

Installation and Operation Instructions

for the

Jøtul GI 645 DV

and

Jøtul GI 645 DV MV*

Astrid

Direct Vent Fireplace Insert

Certified to ANSI Z21.88-2019 • CSA 2.33-2019
CAN/CGA 2.17-M17.

*Conforms to Canadian Energy Efficiency Requirements
- Amendment 15.

Une version française de ce manuel est disponible auprès de votre
revendeur et sur le site www.jotul.ca.

INSTALLER: Leave this manual with the appliance.

CONSUMER: Retain this manual for future reference.

WARNING:

FIRE OR EXPLOSION HAZARD. Failure to follow safety warnings exactly could result in serious injury, death, or property damage.

- Do not store or use gasoline or other flammable vapors and liquids in the vicinity of this or any other appliance.
- **WHAT TO DO IF YOU SMELL GAS**
 - Do not try to light any appliance.
 - Do not touch any electrical switch; do not use any phone in your building.
 - Immediately call your gas supplier from a neighbor's phone. Follow the gas supplier's instructions.
 - If you cannot reach your gas supplier, call the fire department.
- Installation and service must be performed by a qualified installer, service agency or the gas supplier.
- In the Commonwealth of Massachusetts, a carbon monoxide (CO) detector shall be installed in the same room as the appliance.

This appliance may be installed in an aftermarket, permanently located, manufactured home or mobile home, where not prohibited by local codes.

This appliance is only for use with the types of gas indicated on the rating plate. A conversion kit is supplied with the appliance.

DANGER



**HOT GLASS WILL
CAUSE BURNS.
DO NOT TOUCH GLASS
UNTIL COOLED.
NEVER ALLOW CHILDREN
TO TOUCH GLASS.**

A barrier designed to reduce the burn hazard from the hot viewing glass is provided with this appliance and must be installed for the protection of children and other at-risk individuals.

THIS OWNER'S MANUAL PROVIDES INFORMATION TO ENSURE SAFE INSTALLATION AND EFFICIENT, DEPENDABLE OPERATION OF YOUR FIREPLACE INSERT. PLEASE READ THESE INSTRUCTIONS IN THEIR ENTIRETY AND MAKE THEM AVAILABLE TO ANYONE USING OR SERVICING THIS GAS INSERT.

DO NOT ATTEMPT TO ALTER OR MODIFY THE CONSTRUCTION OF THIS APPLIANCE OR ITS COMPONENTS. ANY MODIFICATION OR ALTERATION WILL VOID THE WARRANTY, CERTIFICATION AND LISTING OF THIS APPLIANCE.

THIS HEATER MUST BE INSTALLED AND MAINTAINED BY A QUALIFIED SERVICE AGENCY.

Suggested Tools for Installation and Service

- External regulator (for Propane only)
- Piping that complies with local code
- A manual shut-off valve is included with this appliance, however, an additional T-Handle valve may be required in Massachusetts
- Sediment trap - if required by code
- Tee joint
- Pipe wrench
- Pipe sealant
- 10 mm open end wrench
- 1/2" & 7/16" open end wrench
- Phillips head screwdriver
- Flat head screwdriver
- 1/4" nut driver
- Work Gloves
- Safety glasses
- Torx T-20 screwdriver
- Tin snips
- Glass Frame Latch Tool
- included with appliance.
Retain and store in a secure location.

PLEASE NOTE:

Initial Break-in

It is normal for smoke and odor to occur during the initial stages of operation, depending upon temperatures generated over time. This curing condition can be alleviated by promoting fresh air circulation within the immediate vicinity of the appliance.

Operational Sounds

Please be aware that cast iron and steel components expand and contract with temperature fluctuations that are often accompanied by "creaking" or "pinging" sounds. This is the result of natural thermal activity.

The blower fan will also generate a slight hum at the low setting and progressively increase with the velocity of forced air.

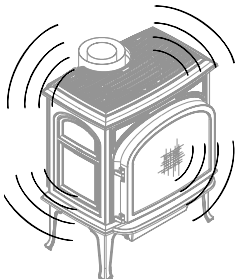

Canada

ENERGUIDE

Gas Fireplace Energy Efficiency Rating

63.03%	62.56%
Natural Gas	Propane

Based on CSA P.4.1-15

Model No. Jøtul GI 645 DV



Canada

ENERGUIDE

Gas Fireplace Energy Efficiency Rating

64.55%	64.57%
Natural Gas	Propane

Based on CSA P.4.1-15

Model No. Jøtul GI 645 DV MV



Installation Requirements for the Commonwealth of Massachusetts

THIS PRODUCT MUST BE INSTALLED BY A LICENSED MASTER OR JOURNEYMAN PLUMBER OR GAS-FITTER WHEN INSTALLED IN THE COMMONWEALTH OF MASSACHUSETTS.

1. If there is not one already present, on each floor level where there are bedroom(s), a carbon monoxide detector and alarm shall be placed in the living area outside the bedroom(s). The carbon monoxide detector shall comply with NFPA 720 (2019 Edition).
2. A carbon monoxide detector shall:
 - a) Be located in the room that houses the appliance or equipment;
 - b) Be either hard-wired or battery powered or both; and
 - c) Shall comply with NFPA 720 (2019 Edition).
3. A Product-approved vent terminal must be used, and if applicable, a Product-approved air intake must be used. Installation shall be in strict compliance with the manufacturer's instructions. A copy of the installation instructions must remain with the appliance or equipment at the completion of the installation.



NATIONAL FIREPLACE INSTITUTE
NFI
CERTIFIED
www.nficertified.org

We recommend that our gas hearth products be installed and serviced by professionals who are certified in the U.S. by the National Fireplace Institute® (NFI) as NFI Gas Specialists.

Table of Contents

- 1. Unpacking the Fireplace3
- 2. Specifications 4
- 3. General Information5
- 4. Safety Information6
- 5. Installation7
 - 5.1 Fireplace Requirements 8
 - 5.2 Hearth and Clearance Protection 8
 - 5.3 Clearances9
- 6. Vent Guidelines.....10
 - 6.1 Masonry Fireplaces11
 - 6.2 Factory-built Fireplaces 12
 - 6.3 Vent Connection 13
- 7. Fireplace Assembly14
 - 7.1 Gas Supply Connection14
 - 7.2 Gas Pressure Test/ High Altitude14
 - 7.3 Fuel Conversion.....16
 - 7.4 Optional Controls18
 - 7.5 Backer Plate Installation.....19
 - Trimable Backer Plate..... 19
 - 7.6 Firebox Panels 20
 - 7.7 Traditional Log Set21
 - 7.8 Beach Fire Log Set 23
 - 7.9 Surround Overlay..... 25
- 8. Operation 26
 - 8.1 Fireplace Operation..... 26
 - 8.2 Blower Operation28
 - 8.3 Thermostatic Operation28
- 9. Maintenance 28
 - 9.1 General and Annual Cleaning.....29
 - 9.2 Gasket Inspection29
 - 9.3 Glass Care/Replacement.....29
- 10. Illustrated Part Breakdowns.....30
- 11. Appendix 34
 - 11.1 Approved Vent Manufacturers34
 - 11.2 Warranty Statement 35
 - 11.3 Troubleshooting Tips 36
- 12. Lighting Instructions..... 39

⚠ INSTALLER NOTE:
Please give this manual to the homeowner and instruct them on basic operation procedures before leaving the premises.

1.0 Unpacking the Fireplace Insert

1. Thoroughly inspect the shipping crate and fireplace for damage and immediately contact the dealer if any is found.
2. The Log Set is shipped separately from the firebox. Do not install it until directed in these instructions.
 - A Miscellaneous Hardware Kit is packed within the firebox crate with this manual. Confirm these contents:
 - Fuel Conversion Kit, LP
 - Fireplace Conversion Notice Plate
 - Rock Wool Ember Fibers
 - Safety Screen Barrier Guidelines
3. Detach the firebox from the pallet with removal of the attachment bracket screws at each side of the firebox base.
4. Remove the Latch Tool from the shipping pallet. Use it to disengage the two spring latches from the glass frame as shown in fig. 1. Engage the tool prong with the Latch and pull the latch hook forward and up to disengage it from the glass frame slot. Pivot the top of the frame forward and lift to disengage it from the glass frame channel at the bottom of the firebox. Set the glass assembly well out of the way on a clean and secure surface.
5. **PRE-INSTALLATION FIT UP:** Leveling bolts are located at each corner of the firebox base to allow a maximum 1/2" adjustment to correct hearth irregularities.
 - Before assembly*, locate the firebox in its final position within the fireplace and adjust the leveling bolts as necessary to level and plumb the unit. Pull the unit back out of the fireplace and read the installation requirements in this manual before proceeding with final assembly and installation.

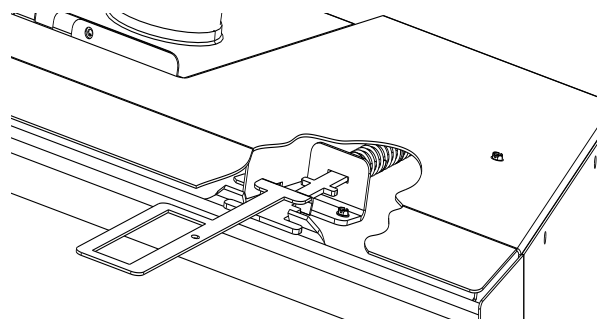

Figure 1
Pull each Spring Latch OUT and UP to disengage it from the Glass Frame.

Jøtul GI 645 DV / DV MV Astrid Direct Vent Gas Fireplace Insert

Manufactured and Distributed by:
Jøtul North America
Gorham, Maine USA

2.0 Specifications

Input Rates:

Natural Gas
38,000 BTU/hr. Maximum Input Rate
21,000 BTU/hr. Minimum Input Rate

Propane
36,500 BTU/hr. Maximum Input Rate
20,000 BTU/hr. Minimum Input Rate

Inlet Pressure:	MIN.	MAX.
Natural Gas:	5.0 WC (1.00 kPa)	7.0 WC (1.74 kPa)
Propane:	11.0 WC (3.00 kPa)	14.0 WC (3.48 kPa)

Manifold Pressure:	MIN.	MAX.
Natural Gas:	1.2 WC (0.27 kPa)	3.8 WC (0.94 kPa)
Propane:	2.9 WC (0.72 kPa)	11.0 WC (2.99 kPa)

Orifice Sizes:	NG	LP
Altitude: 0 - 2000 ft. (0-609.6 m)	#32	1.8mm

	NG	LP
Steady State Efficiency:	71.21%	72.83%
A.F.U.E. Efficiency:	73.3%	73.2%
CSA P.4.1-15 Fireplace Efficiency:		
GI 645 DV	63.03%	62.56%
GI 645 DV MV	64.55%	64.57%

Test Standards

This appliance complies with National Safety standards and is tested and listed by Intertek Testing Services NA Inc. of Middleton, Wisconsin.

In addition, the Jøtul GI 645 DV and DV MV gas fireplace inserts have been tested and listed as direct vented gas fireplace heaters and listed to ANSI z21.88-2019 • CSA 2.33-2019 Standard for Vented Gas Fireplace Heaters and CAN/CSA 2.17-2019 Standard for Gas-Fired Appliances for use at High Altitudes.

Canadian energy performance verified: Conforms to CAN/CSA P.4.1-15 Energy Performance Standard for Fireplace Efficiency by ETL-Intertek, Arlington Heights, Illinois.

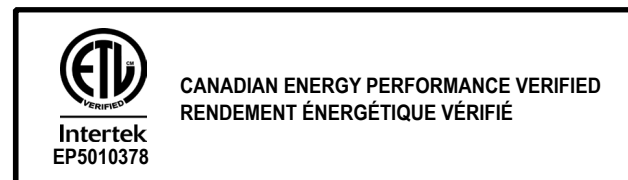

Options & Accessories

- Traditional Log Set 158153
- Beach Fire Log Set 158154
- Black Reflective Glass Panel Kit 158131
- Traditional Red Brick Panel Kit..... 158132
- Brownstone Brick Panel Kit 158195
- Fluted Panel Kit 158133
- Cast Iron Overlay, Matte Black 158089
- Cast Iron Overlay, Blue Black Enamel 158090
- Steel Overlay - Rectangular, Black Powder Coat 158125
- Steel Overlay - Rectangular, Jøtul Iron Powder Coat 158126
- Steel Overlay - Rectangular, Bronze Powder Coat 158127
- Steel Overlay - Arched, Black Powder Coat 158318
- Steel Overlay - Arched, Bronze Powder Coat 158319
- Steel Overlay - Arched, Iron Powder Coat..... 158320
- Fuel Conversion Kit - NG to LP (included) 158190
- Fuel Conversion Kit - LP to NG..... 158191
- High Altitude Adjustment Kit, LP 158187
- High Altitude Adjustment Kit, NG..... 158192
- Remote Control 224910
- Wall Thermostat 750003
- Mantle Heat Shield..... 158201

Backer Plate Options

All Backer Plates include Hanger Brackets for attaching the Cast Iron or Steel Surround Overlays.

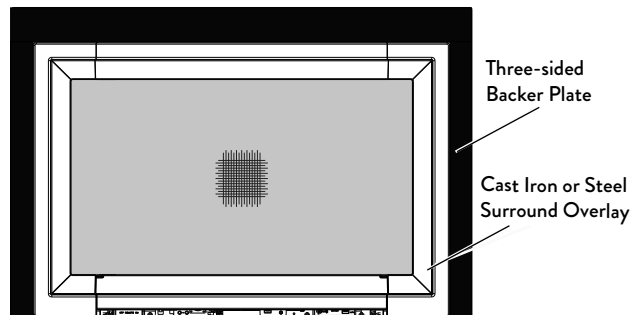

Three-sided Overlay Backer Plate, Matte Black Powder Coat

- Overlay Backer Frame, 44" x 30" 158181
- Overlay Backer Frame, 45" x 32" 158182
- Overlay Backer Frame, 46" x 34" 158183

Three-sided Trimmable Overlay Backer Plate, Matte Black Paint

- Trimmable Backer Plate, 3 Sided, 47-3/4" x 38" 158184

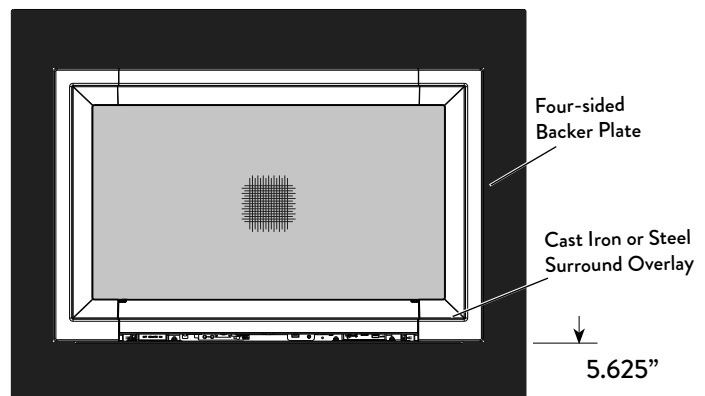

Four-sided Trimmable Backer Plate, Matte Black Paint

- Trimmable Backer Plate, 4 Sided, 47-3/4" x 38" 158185

*Optional Mantle Heat Shield 158201 is attaches to backer plates. See fig. 5.6 for clearances.

3.0 General Information

THIS HEATER MUST BE INSTALLED AND MAINTAINED BY A QUALIFIED SERVICE AGENCY.

DO NOT ATTEMPT TO ALTER OR MODIFY THE CONSTRUCTION OF THIS APPLIANCE OR ITS COMPONENTS. ANY MODIFICATION OR ALTERATION WILL VOID THE WARRANTY, CERTIFICATION AND LISTING OF THIS APPLIANCE.

IMPORTANT: SAVE THESE INSTRUCTIONS.

1. The installation and repair of this appliance must be done by a qualified service person. Failure to properly install and maintain this heater could result in an unsafe or hazardous installation, which may result in a fire, explosion, property damage, personal injury or loss of life.
2. This appliance should be inspected before use and at least annually. More frequent cleaning may be required due to excessive lint from carpeting, bedding material, pet hair, dander, etc. It is imperative that control compartments, burners and circulating air passageways of the appliance be kept clean.
3. This appliance may be installed in an aftermarket permanently located, manufactured (mobile) home, where not prohibited by local codes.
This appliance is only for use with the type(s) of gas indicated on the rating plate. This appliance is not convertible for use with other gases, unless a certified kit is used.
4. The installation must conform to local codes. Your local Jøtul authorized dealer can assist you in determining what is required in your area for a safe and legal installation. Some areas require a permit to install a gas burning appliance. Always consult your local building inspector or authority having jurisdiction to determine what regulations apply in your area.

In the absence of local codes, the installation requirements must comply with the current National codes. In the U.S., these requirements are established in the National Fuel Code, ANSI-Z223.1.(NFPA 54). In Canada, the codes have been established in CAN/CGA B149 Fuel Installation Code.
5. Do not operate this fireplace if any part of it has been under water.

Immediately call a qualified service technician to inspect the heater and to replace any part of the control system and any gas control which has been under water.
6. Do not operate the fireplace with the glass front removed, cracked, scratched, or broken. Replacement of the glass should be done by a licensed or qualified service person. Only remove glass for routine service. Always handle glass

carefully.

7. Notify your insurance company before proceeding with installation of this fireplace.
8. It is normal that burner ignition and extinction be accompanied by a muffled “woof” or “thud” noise. Discontinue use and call a qualified service technician if these functions become unusually loud or disturbing.



INITIAL FIRING PROCESS - Heat-curing the Paint and Log Set

This appliance has been painted with the highest quality coating used in the hearth industry. Manufacturers have selected this product because it has been proven durable, colorfast, and beautiful at temperatures up to 1200°F / 650°C. Although the paint has been air-dried at the factory, it must be heat-cured in order to maximize its coating properties and durability. This process occurs during initial firing of the appliance and will generate odor and some visible smoke.

We recommend you do the following BEFORE operating the appliance for the first time:

1. **Ventilate:** Open doors and windows and use a fan to circulate fresh air throughout the room.
2. **Vacate:** The fumes are non-toxic, but can be uncomfortable for babies, small children, pregnant women, elderly, pets, or anyone having breathing difficulties.

Gas Appliance Curing Process

1. *After the installer has confirmed proper burner function at all heat levels, the homeowner should operate the appliance at a low setting for 2-4 hours, followed by 2-4 hours operation at a high setting.*
2. *Off-gassing by paint and log set ceramic material may leave a white, powdery deposit on the inside surface of the glass panel. **This residue must be removed using a non-abrasive household glass cleaner or warm water to prevent permanent etching of the glass.***

DO NOT USE AMMONIA-BASED CLEANERS.

See Section 8, OPERATION for detailed, day-to-day operating procedures.

4.0 Safety Information

- Due to the high operating temperatures, this appliance should be located out of traffic and away from furniture, draperies, etc. Maintain proper clearance to combustible mantels and fireplace trim.
- Children and adults should be alerted to the hazards of high surface temperatures and should stay away to avoid burns or clothing ignition.
- Young children should be supervised while they are in the same room as the appliance. Toddlers, young children and others may be susceptible to accidental contact burns. A physical barrier, such as a child guard, is recommended to be used if there are at-risk individuals in the house. To restrict access to a fireplace or stove, install an adjustable safety gate to keep toddlers, young children and other at-risk individuals out of the room and away from hot surfaces.
- An integrated safety screen is provided with this appliance designed to reduce the risk of burns from the hot viewing glass and must remain installed for the protection of children and other at-risk individuals.
- If the safety screen becomes damaged, the screen shall be replaced only with the Jøtul Screen Barrier part number 226508 (Steel Overlay Assembly) or 226363 (Cast Iron Overlay Assembly).
- Any safety screen, glass panel, guard, or barrier removed for servicing an appliance must be replaced prior to operating the appliance.
- Clothing or other flammable materials should not be placed on or near the fireplace.
- NEVER allow anyone to use the fireplace if they are unfamiliar with its operation.
- NEVER store or use gasoline or any other flammable vapors or liquids in the vicinity of the fireplace.
- NEVER burn any solid materials (wood, cardboard, paper, coal, etc.) in this gas fireplace. Use with natural gas or propane fuels ONLY.
- Do not slam or strike the glass panel.
- This appliance is NOT for use with aftermarket glass doors. This appliance is approved for use only with the surround panel options listed on page 4 of this manual.
- Wear gloves and safety glasses while installing or performing maintenance procedures on this appliance.
- This fireplace insert is specifically designed for use with 3" and 4" diameter listed, flexible gas liners.



Electrical Hazards

- This appliance requires 120 VAC power to operate the blower.
- Be aware of electrical wiring locations when cutting holes in walls and ceilings for termination.
- The blower must be electrically grounded in accordance with local codes or, in the absence of local codes, with the current ANSI/NFPA 70, National Electrical Code or CSA C22.1-Canadian Electrical Code.
- The blower is supplied with a three-prong (grounding) plug for protection against shock hazard and should be plugged directly into a properly grounded three-prong receptacle. **DO NOT CUT OR REMOVE THE GROUNDING PRONG FROM THE PLUG.**
- Always disconnect the power supply when performing any service on the fireplace.

5.1 Fireplace Requirements

This appliance is approved for installation into a solid fuel-burning, factory-built fireplace, or a code-approved, solid fuel-burning masonry fireplace. An acceptable fireplace cavity must have the minimum dimensions specified in fig. 5.2.

Do not modify or alter the construction of the gas insert or any of its components to enable it to fit into a fireplace. Any modification of the insert will void the warranty, certifications and approvals of the unit and could be dangerous.

Figure 5.2.

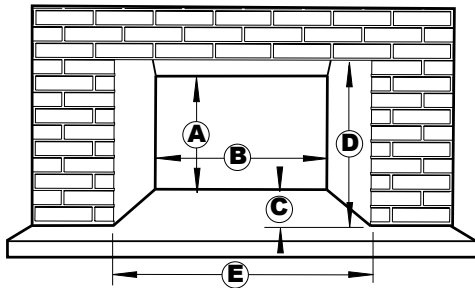

Minimum Fireplace Dimensions

A - Inside Height =	19"
B - Inside Width =	23 3/4"
C - Inside Depth =	16 1/2"
D - Opening Height =	24"
E - Opening Width =	33 3/4"

Maximum Fireplace Opening

with Cast Iron Overlay:

Will cover a maximum fireplace opening 26 3/8" high x 35 5/8" wide resulting in a 1/4" face overlap.

Backer Plate Options

The Backer Plate functions to neatly cover the fireplace opening between the insert shell and the fireplace walls.

Standard Backer Plates are fabricated of 16 gauge, aluminized steel, finished in high-temperature Matte Black powder coating. Trimmable Backer Plates are fabricated of 22 ga. aluminized steel finished in Matte Black paint.

Choose an overall size that is at least 1 inch larger than your fireplace opening.

158181	3-Sided Backer Plate -	44"W x 30"H
158182	3-Sided Backer Plate -	Trimmable plate is intended for flush-faced fireplace installations.

5.2 Clearance Requirements

The following clearances and hearth specifications are the minimum requirements for installing this appliance into a solid fuel-burning fireplace. See figs. 5.3-5.6.

A combustible surface is anything that can burn (i.e. sheet rock, wallpaper, wood, fabrics etc.). These surfaces are not limited to those that are visible and also include materials that are behind non-combustibles.

If you are not sure of the combustible nature of a material, consult your local fire officials. Remember, "Fire Resistant" materials are considered combustible; they are difficult to ignite, but will burn. Also, "fire-rated" sheet rock is considered combustible.

Always maintain the proper clearances to allow for the flow of ventilation air around the insert.

5.3 Hearth Protection

Hearth protection in front of the GI 645 DV MV must be composed of masonry material extending to each side of the fireplace opening and 12" forward from the fireplace facing material.

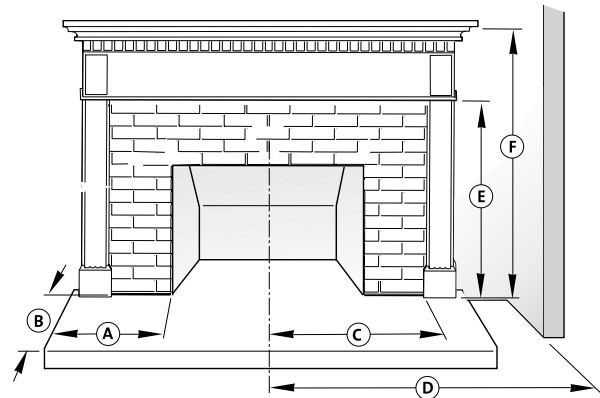

Figure 5.3. Hearth, Trim and Wall clearances.

A: Hearth Protection Width: from fireplace opening

- Unit flush: Min. 4 5/8"
- Unit raised minimum 6" off floor: 0"

B: Hearth Protection Depth: from fireplace opening

- Unit flush with hearth: 12"
- Unit raised minimum 6" off floor: 0"

C: Side Trim Clearance:

- Up to 6" depth, from fireplace center line: 21 1/8"

D: Side Room Wall Clearance:

- From the fireplace center line: 26 5/8"

E: Top Trim Clearance from hearth: See fig. 5.5

F: Mantel Clearance from hearth: See fig. 5.5

NOTE - Raised Hearth: Forward hearth protection may be reduced by two inches for every inch of fireplace floor elevation. Fig. 5.4.

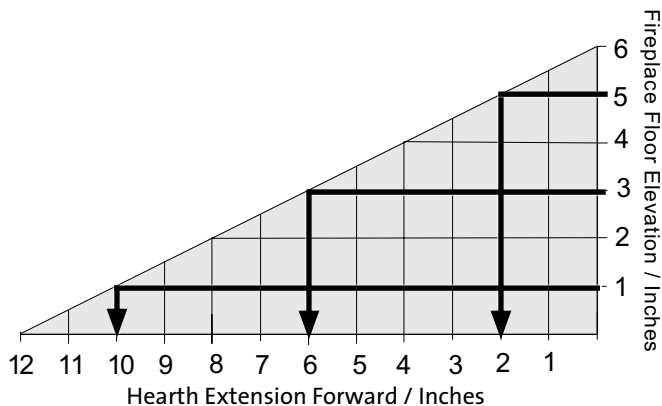

Figure 5.4. Hearth reduction slope.

5.4 Mantel without Shield and Ceiling Clearances

Measure clearances from the finished floor of the fireplace opening. See fig. 5.5.

Mantel Projection	Clearance from Hearth
A: 12"	48 1/8"
B: 10"	47 7/8"
C: 8"	47 1/4"
D: 6"	46 5/8"
E:*	4" 46"

*Also to Top Trim

Minimum Ceiling Height from Hearth Surface:
64 3/4"

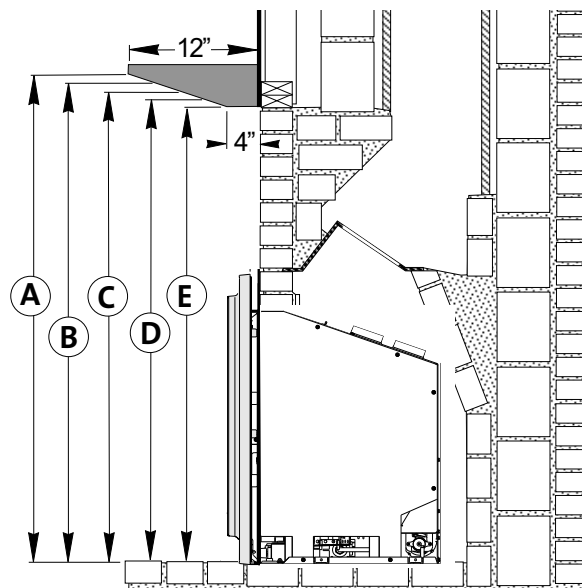

Figure 5.5. Baseline Mantel and Trim clearance requirements.

5.5 Mantel with Shield (#158201) and Ceiling Clearances

Measure clearances from the finished floor of the fireplace opening. See fig. 5.6.

Mantel Projection	Clearance from Hearth
A: 12"	42 1/2"
B: 10"	41 1/2"
C: 8"	40 1/2"
D: 6"	39 1/2"
E:* 4"	38 1/2"

*Also to Top Trim

Minimum Ceiling Height from Hearth Surface:
64 3/4"

*Mantle Heat Shield 158201 mounts to backer plates

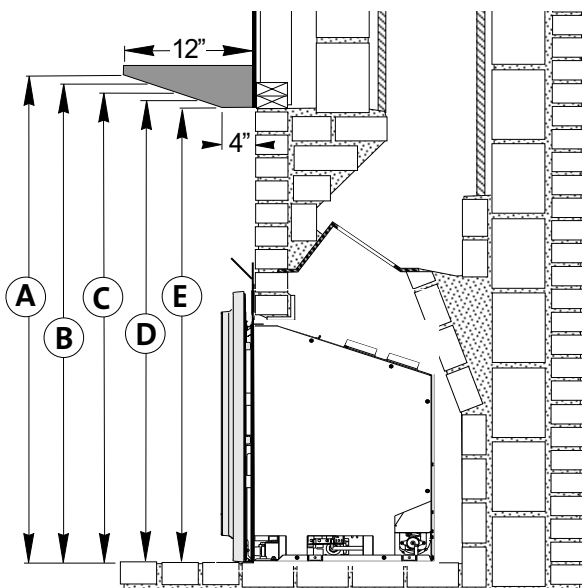

Figure 5.6 Baseline Mantel with Shield and Trim clearance requirements.

6.0 Vent Guidelines

- All vent components must be installed in accordance with the terms of their listing and manufacturer’s instructions. See the Appendix on page 34 for a listing of approved vent manufacturers. See fig. 6.3 on approved OEM Vent Collar Adaptors.
- The minimum height of termination cap from the top of the unit shall be no less than 10 ft. (3.05 m), and the maximum height shall be no more than 35 ft. (10.67 m). See figures 6.1 - 6.2.
- Steep roofs, nearby trees, or predominantly windy conditions can promote weak draft or occasional downdrafts. In such cases, increasing the height of the vent or installation of high wind termination caps may alleviate the condition.
- HORIZONTAL RUNS are not permitted anywhere in the venting system.
- Vent liners may be no less than 3 inches diameter nor greater than 3 inches diameter *with the following exception: PROPANE NOTICE: For LP installations with vent runs greater than 10’, it is recommended that a 4” exhaust liner be used to ensure best operating performance. This is especially appropriate for installations in warmer climates and intended for extended run times. Vent pipe adapters (3” to 4”) are available from Jøtul-approved venting manufacturers. When a 4” Exhaust liner is used, it is recommended that a 3” Intake liner be run all the way to the vent terminus.*
- Any unused flue or masonry enclosure can be used as a passageway for venting provided the flue is relined using 3” or 4” listed, flexible gas liner. The remaining space around the liner in a masonry or factory-built flue CANNOT be used to vent any other appliance.
- The gas liner may not be exposed to any living space.
- Installation of any components not manufactured or approved by Jøtul, or failure to meet all clearance requirements will void all warranties and could result in property damage, bodily injury, or loss of life.
- Never modify any venting component, or use any damaged venting product.

- THE GAS APPLIANCE AND VENT SYSTEM MUST BE VENTED DIRECTLY TO THE OUTSIDE OF THE BUILDING, AND NEVER ATTACHED TO A CHIMNEY SERVING A SOLID FUEL OR GAS BURNING APPLIANCE.
- The minimum vent height above the roof or adjacent walls is specified by building codes. A general guide to follow is the Gas Vent Rule below.

Vent Installation Procedure

This appliance must be vented through the chimney by a pair of 3 inch flexible aluminum liners listed for use with gas appliances. One duct is attached to the exhaust port on the top of the unit and will carry the exhaust gases to the outside of the house. This exhaust liner must run the full length of the chimney and be directly connected to the chimney termination cap. See figures 6.1 - 6.2.

The other 3 inch liner will be attached to the air intake port and will provide fresh air for combustion to the unit. This liner must extend through the damper area of the fireplace and at least into the first tile liner of the chimney. (U.S. ONLY). This liner can also extend the full length of the chimney and connect to the termination cap. **SEE NOTICES BELOW.** See also figures 6.1-6.2.

NOTICE

If the intake flex does not extend the full length of the chimney and connect to the unit and the termination cap - **A NONCOMBUSTIBLE BLOCK OFF PLATE MUST BE CONSTRUCTED AND INSTALLED ABOVE THE UNIT BELOW THE END OF THE INTAKE DUCT** (normally at the damper area). See figure 6.1.

To avoid cross-venting the insert, label the duct to be used for the exhaust conduit at both the top and bottom ends. This ensures that the exhaust duct will be attached to the correct collar on the insert and on the chimney termination kit.

CANADA NOTE: Both Intake and Exhaust ducts must extend the full length of the chimney and be connected to both the unit and the termination kit.

NOTICE

THE USE OF AN EXISTING CHIMNEY AS AN AIR INTAKE IS NOT COVERED UNDER THE ANSI Z21.88-2014 / CSA 2.33-M04 TEST METHODS AND RESULTING ITS/WHI PRODUCT CERTIFICATION. THE CODE AUTHORITY HAVING JURISDICTION MUST BE CONSULTED PRIOR TO PROCEEDING WITH THIS INSTALLATION METHOD.

GAS VENT RULE

ROOF SLOPE	Minimum Height From Roof
Flat to 6/12	1’0”
Over 7/12 to 9/12	2’0”
Over 10/12 to 12/12	4’0”
Over 13/12 to 16/12	6’0”
Over 17/12 to 21/12	8’0”

6.1 Masonry Fireplace

Wear Safety Gloves!

1. Measure height of the chimney to fireplace opening.
Determine if both the intake and exhaust will be extended to the top of the chimney. In Canada, both liners must extend the full length of the chimney and be connected to both the unit and the termination kit.
2. Cut the appropriate lengths of flex duct for both the intake and exhaust. **Label both ends of the Exhaust duct for ease of identification inside the house.**
3. Follow the manufacturer's instructions to attach the ends of the duct(s) to the chimney termination kit as appropriate.
4. Drop the liners down the chimney from the top and rest the termination kit atop the chimney.
5. Seal the chimney termination kit to the top of the chimney flue with high temperature sealant.
6. Secure the appropriate direct vent cap to the termination kit.
7. Inside the fireplace, fully extend the duct and trim any excess so that the ends hang approximately 18 3/4" from the floor of the fireplace.
8. If the Intake duct is not attached to the chimney termination kit:
 - A. Install a length of flex duct that extends at least into the first flue tile.
 - B. The fireplace chimney flue must be permanently sealed-off from the room.
 - C. A direct vent cap is required to allow fresh air into the chimney flue and ultimately into the intake duct to the insert.
 - D. Attach the Fireplace Conversion Notice to the back of the fireplace if appropriate.
9. Remove the Vent Adaptor from the unit by pushing it to the rear. Connect both ducts to the appropriate collars.
10. Position the insert **without Backer Plate** half-way inside the fireplace and start the Vent Adaptor onto the top of the firebox. As you face the front of the insert, the Intake collar is on the left and the Exhaust is on the right.
11. Secure the ducts to the appropriate collars on the Vent Adaptor with sheet metal screws or duct clamps. It is important to have a good seal between the ducts and the vent adaptor, however, sealant is not required. See Vent Connection instructions on page 13.

WARNING: FAILURE TO POSITION THE PARTS IN ACCORDANCE WITH THIS DIAGRAM OR FAILURE TO USE ONLY PARTS SPECIFICALLY APPROVED WITH THIS APPLIANCE MAY RESULT IN PROPERTY DAMAGE OR PERSONAL INJURY.

IMPORTANT NOTICE:
INSTALLATION OF A HIGH-WIND TERMINATION CAP IS RECOMMENDED FOR ALL APPLIANCES TO HELP INCREASE PERFORMANCE.

We Recommend:

- M&G Duravent - Use Wind Screen #46DVA-VWG.

We do not recommend use of "prairie-style" wind caps.

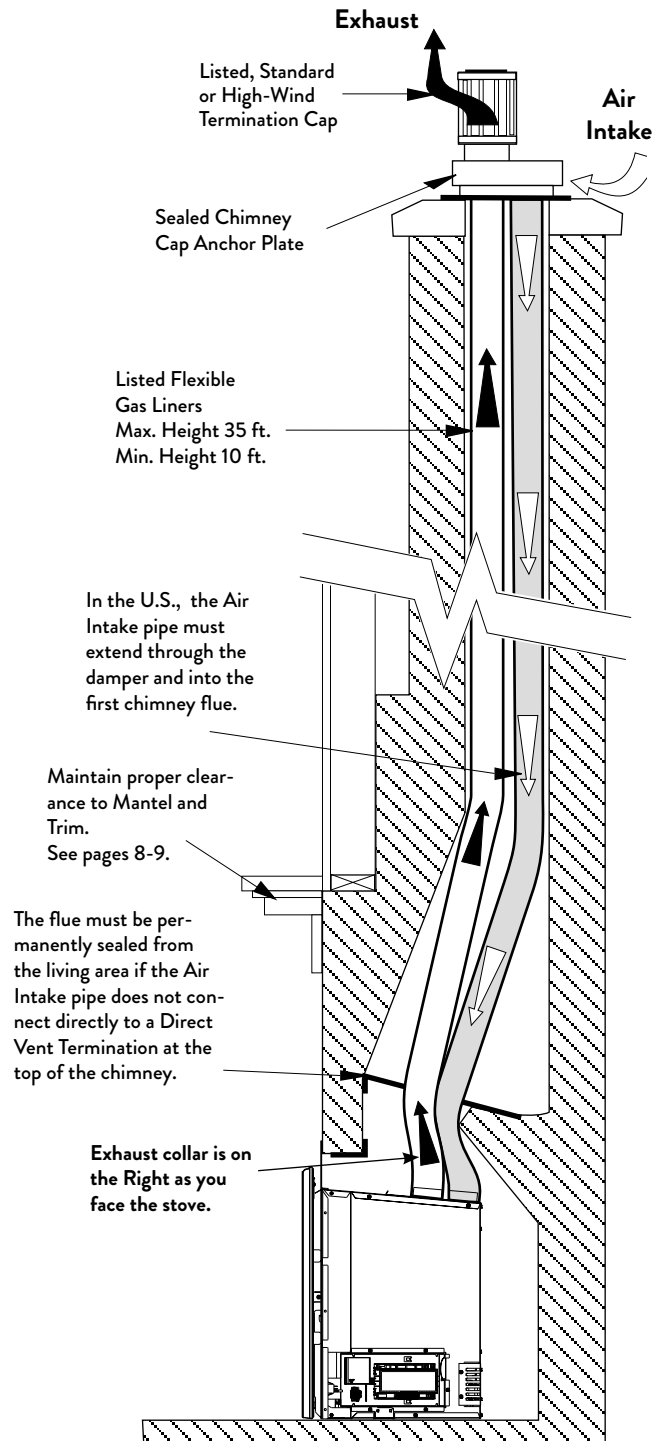

Figure 6.1. Masonry Fireplace Venting Configuration.
IN CANADA: Air intake must connect to chimney cap.

6.2 Factory-built Fireplace

IMPORTANT:

BEFORE STARTING THIS INSTALLATION, MAKE SURE THAT A GAS LINE CAN BE INSTALLED OR IS INSTALLED TO THE FIREBOX. THIS SHOULD ONLY BE DONE BY A QUALIFIED OR LICENSED PLUMBER OR GAS FITTER.

A factory-built fireplace will require modification prior to installation of the insert.

Modification

1. Remove any factory-built glass doors, screen rails, screen mesh, fuel grates and other components attached to the firebox. Smoke shelves, shields, fuel grates and baffles may be removed if attached by mechanical fasteners. These should be kept for potential future re-installation. Do not cut out any sheet metal parts of the fireplace into which the insert will be installed.
If the factory-built fireplace has no gas access inlet(s) provided, an access hole of 1 1/2" or less may be drilled through the lower sides or bottom of the firebox in a proper workmanship-like manner. This access hole must be sealed with noncombustible insulation after the gas supply has been installed.
2. Remove the damper assembly. This includes the damper blade, handle and any linkage. Two 3" liners must be able to pass through the damper area.
3. Remove any fire screen or door assembly. This is usually accomplished with removal of a support rod on the inside of the fireplace frame.
4. Remove the metal ash lip, if appropriate, to allow the insert to sit flat within the fireplace. Be sure to reinstall any screws removed.
5. Attach the fireplace conversion notice to the back of the factory-built fireplace.

VENT NOTICE:

If the intake flex does not extend the full length of the chimney and connect to the unit and the termination cap - A METAL BLOCK OFF PLATE MUST BE CONSTRUCTED AND INSTALLED ABOVE THE UNIT BELOW THE END OF THE INTAKE DUCT (normally at the damper area). See fig. 6.2.

To avoid cross venting the insert, label the duct to be used for the exhaust conduit at both the top and bottom ends. This ensures that the exhaust duct will be attached to the correct collar on the insert and on the chimney termination kit.

CANADA NOTE: Both Intake and Exhaust ducts must extend the full length of the chimney and be connected to both the unit and the termination kit.

IMPORTANT NOTICE:
INSTALLATION OF A HIGH-WIND TERMINATION CAP IS RECOMMENDED FOR ALL APPLIANCES TO HELP INCREASE PERFORMANCE.

We Recommend:

- M&G Duravent - Use Wind Screen #46DVA-VWG.

We do not recommend use of "prairie-style" wind caps.

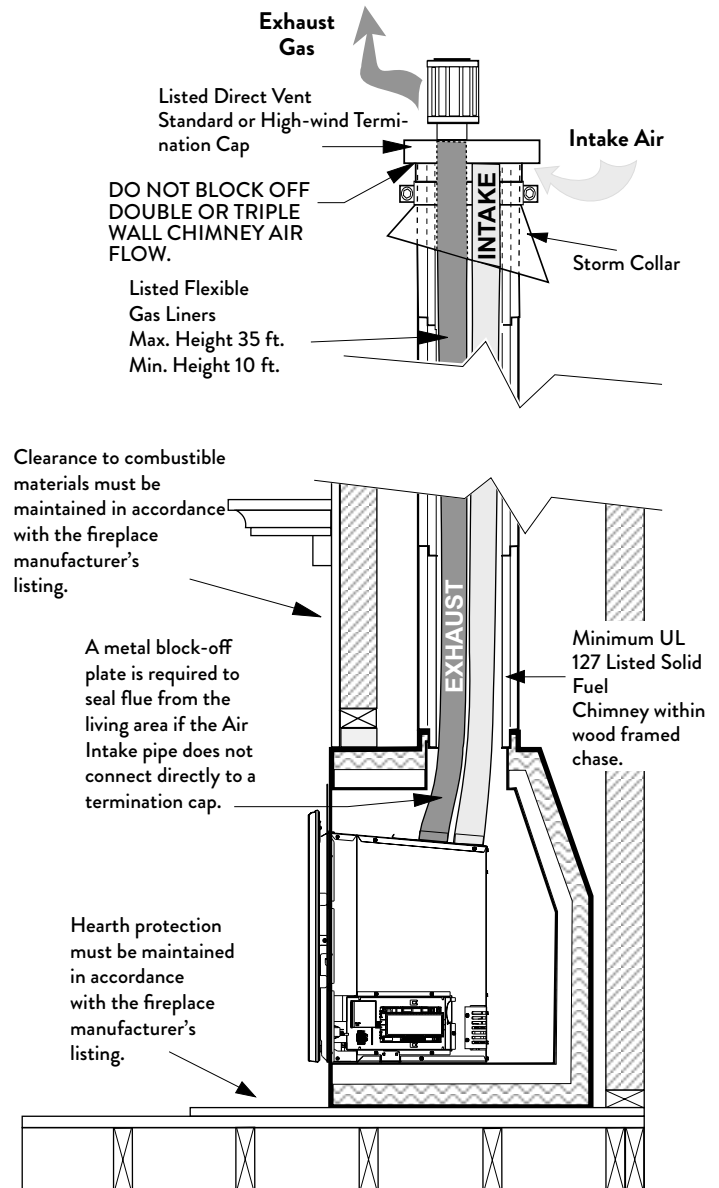

Figure 6.2. Venting through prefabricated fireplace chimney.

IMPORTANT NOTICE:

THE USE OF AN EXISTING CHIMNEY AS AN AIR INTAKE IS NOT COVERED UNDER THE ANSI Z21.88-1999 / CSA 2.33-M04 TEST METHODS AND RESULTING ITS/WHI PRODUCT CERTIFICATION. THE CODE AUTHORITY HAVING JURISDICTION MUST BE CONSULTED PRIOR TO PROCEEDING WITH THIS INSTALLATION METHOD.

Prefabricated Fireplace Vent Procedure

1. Measure height of the chimney to fireplace opening. Determine if both the intake and exhaust will be extended to the top of the chimney.
2. Cut the appropriate lengths of flex for both the intake and exhaust.
3. **If the intake flex will be attached to the chimney termination kit:** Attach the appropriate ends of the flex to the chimney termination kit.

CAUTION: AVOID CROSS-VENTING THE FLEX PIPE. Label both ends of the exhaust pipe to ease identification inside the house.

4. Drop the liners down the chimney from the top and rest the termination kit atop the chimney.
5. Seal the chimney termination kit to the top of the chimney pipe with high temperature sealant.
6. Secure the appropriate DIRECT VENT CAP to the termination kit.
7. Inside the fireplace, fully extend the flex duct and cut off any excess so that the liners extend approximately 18 3/4" from the floor of the fireplace.
8. **If the intake flex is NOT attached to the chimney termination kit:** See VENT NOTICE on page 12.
 - A. It is necessary to install a minimum 6 foot length of flex pipe into the flue for the intake air.
 - B. A METAL damper block off plate must be constructed and installed in the damper area to completely seal off the flue from the room. Cut holes for both the intake and exhaust liners in the block off plate.
 - C. A direct vent cap is still required to allow fresh air into the chimney flue and ultimately into the intake flex and insert.
 - D. Attach the Fireplace Conversion Notice to the back of the fireplace if appropriate.
9. Backer Plates or the Cast Iron Overlay panel must not block or seal any ventilation openings on the prefabricated fireplace.

WARNING: FAILURE TO POSITION THE PARTS IN ACCORDANCE WITH THESE DIAGRAMS OR FAILURE TO USE ONLY PARTS SPECIFICALLY APPROVED WITH THIS APPLIANCE MAY RESULT IN PROPERTY DAMAGE OR PERSONAL INJURY.

6.3 Vent Connection

Wear Safety Gloves!

Test fit the firebox in its final position to confirm it is level and plumb before connection to the vent system. A leveling bolt is located at each corner in the base of the firebox to allow a maximum 1/2" adjustment for hearth irregularities. Front bolts are accessible in each side compartment through the fireplace front. Tip the firebox forward to adjust the rear bolts out of the base.

1. Refer to fig. 6.3. Remove the lock screw from the Vent Adaptor panel and detach it from the firebox. Keep the screws for reinstallation.
2. **NOTE THE EXHAUST ID ON THE VENT PANEL.** Attach the flex liners to the appropriate collars on the Vent Adaptor and secure each using sheet metal screws or duct clamps. It is important to have a good seal between the ducts and the vent adaptor, however, no sealant is required. Leaking vents can result in poor performance or draft reversal.
3. Position the firebox under the Adaptor panel and use the Latch Tool to engage the panel with the associated pins on the firebox Vent Manifold.
4. Reinstall the Lock Screw to secure the adaptor panel to the firebox.
5. If appropriate, the backer plate should be installed before pushing firebox into its final position. Refer to section 7.8 for backer plate installation.

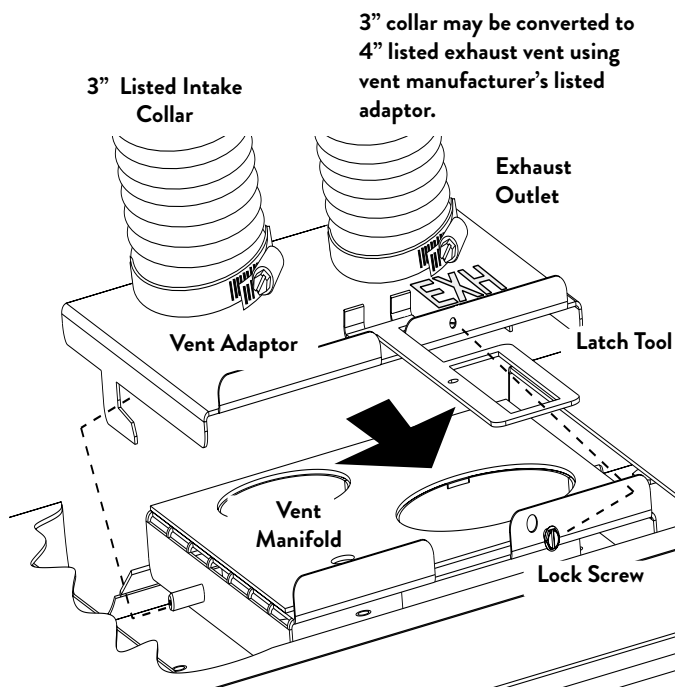

Figure 6.3. Vent Adaptor assembly.

3" to 4" OEM Vent Collar Adaptors:

ICC: TM-L34

DuraVent: 3GVBTI4 P/N 810004525

7. Fireplace Assembly

Before beginning final assembly, push the insert partially into the fireplace and adjust the leveling bolts located at each corner as appropriate to achieve a level and plumb installation.

Complete assembly procedures 1-5 before placing the insert within the fireplace.

1. Gas Connection and Leak Test
2. Gas Pressure Test
3. Fuel Conversion - if appropriate
4. Optional Thermostat or Remote Control
5. Backer Plate Installation
6. Optional Firebox Panel Kits
7. Log Set

7.1 Gas Supply Connection

The gas supply line connection is made to the valve on the left side of the unit facing the front. The gas supply line should be a minimum of 3/8" in diameter, or the appropriate size to provide sufficient gas pressure to the valve regardless of the input setting. See fig. 7.1-7.2.

This appliance is shipped with a 36" length of 3/8" flexible gas line to ease installation and service. However, for those areas where flexible gas lines are not permitted, use of a 3/8" iron nipple and union is recommended. See fig. 7.1.

The use of Flexible Gas Appliance Connectors is acceptable in many areas in the U.S., however, Canadian methods vary depending on local code.

ALL INSTALLATIONS MUST COMPLY WITH LOCAL CODE OR IN THE ABSENCE OF LOCAL CODE, MUST COMPLY WITH THE MOST RECENT EDITION OF THE NATIONAL FUEL GAS CODE ANSI Z-223.1/NFPA 54 OR CAN-B149.

An integrated gas cock must be installed into the fuel supply line upstream of the valve. This feature conforms to building codes requiring a shut-off valve be located within the same room as the appliance. The gas cock allows for the disconnection of the appliance for servicing and maintenance. See fig. 7.1.

Secure all joints tightly using appropriate tools and sealing compounds. Propane fuel requires sealant specifically resistant to propane chemical degradation.

LEAK TEST: Open the gas supply valve and test for gas leaks using a soapy water solution or digital gas sensor. **DO NOT** use an open flame to check for leaks. Tighten or reconnect any leaking joint and retest to confirm secure fittings.

INSTALLATION OF A T-HANDLE GAS COCK IS REQUIRED IN MASSACHUSETTS IN COMPLIANCE WITH CODE 248 CMR.

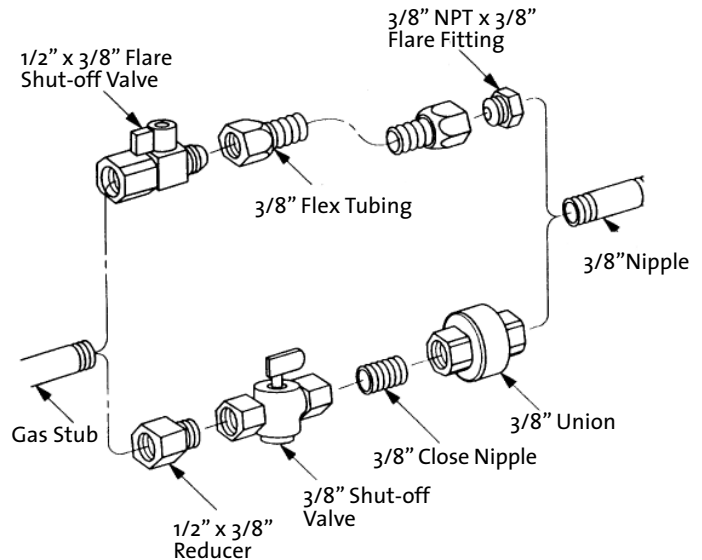

Figure 7.1. External gas connection components.

7.2.1 Gas Pressure

Correct gas pressure is essential for efficient and safe operation of this appliance. It is important that the correct pressure is established at the time of the installation. Proper gas pressure provides a consistent flow of gas to the appliance and is instrumental in checking for gas leaks.

Pressure Test: Attach a manometer to the appropriate test point on the valve. See fig. 7.2.1. The gauge connections are located on the front of the valve. Connections are identified by:

A - for Inlet or Supply Pressure (the amount of gas coming to the valve.)

B - for Manifold Pressure (the amount of gas that is coming out of the valve to the burner.)

ALWAYS TEST INLET PRESSURE WITH VALVE REGULATOR CONTROL KNOB SET ON "HIGH" AND WITH ALL OTHER GAS APPLIANCES IN THE RESIDENCE TURNED ON.

7.2.2 High Altitude Adjustment

The decreased atmospheric pressure of higher altitudes affects heat value of gaseous fuels. Most gas suppliers derate the gas intended for use at elevations above 2000 feet. Check with your gas supplier before performing derate adjustment to the burner. If the gas supplier does not derate fuels, install High Altitude Adjustment Kit #158187 for Propane and Kit #158192 for Natural gas.

U.S. & Canada per
ANSI Z21.88-2009 • CSA 2.33-2009, CAN/CGA 2.17

Orifice Sizes for 610-1370 meters (2000-4500 ft.):

Natural Gas: #33
Propane: 1.75 mm

Rating Specifications - BTU/hr:	NG	LP
Min. Input Rate, 2000 - 4500 ft.	19950	19000
Max. Input Rate, 2000 - 4500 ft.	36100	34675

See data on the stove rating plate for additional information. At higher altitudes, consult the local gas distributor or the authority having jurisdiction for proper rating methods. If the installer must convert the unit to adjust for varying altitudes, the information label must be filled out and applied to the appliance at the time of the conversion.

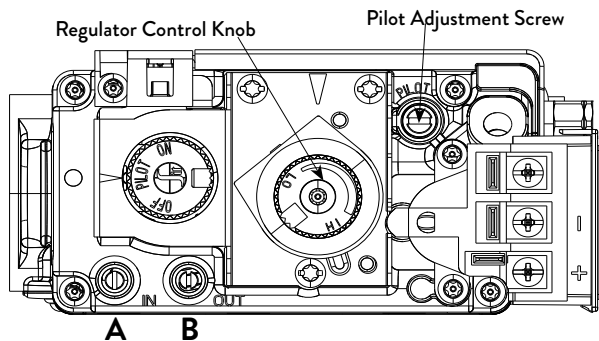

Figure 7.2.1 Valve pressure test points and pilot adjustment.

REQUIRED INLET GAS PRESSURES

(inches water column)

	MIN	MAX
NATURAL GAS	5.0 WC	7.0 WC
PROPANE	11.0 WC	14.0 WC

REQUIRED MANIFOLD PRESSURES

(inches water column)

	MIN	MAX
NATURAL GAS	1.2 WC	3.8 WC
PROPANE	2.9 WC	11.0 WC

Symptoms of incorrect gas pressure include:

Insufficient gas pressure:

- Small pilot flame which can result in poor burner ignition and/or frequent burner outages.
- Little variation in flame picture between HI and LO regulator settings.
- Insufficient gas to support more than one appliance causing nuisance outages or gas surges.

Excessive gas pressure:

- Permanent damage to valve causing complete appliance shut down.
- Too large a pilot flame resulting in overheating of the flame sensor and consequent shut down.
- Sooting due to impingement and/or incorrect fuel to air mix.

WARNING

DO NOT ALLOW THE INLET GAS PRESSURE TO EXCEED 14.0" WC (OR 1/2 PSIG) AS SERIOUS VALVE DAMAGE MAY RESULT.

Derating Procedure

- Follow the steps for Burner Injector replacement in the Fuel Conversion procedure on page 16. Use the injectors supplied with the adjustment kit. Detailed instructions are also included in the kit.
- Conduct gas leak and gas pressure tests as detailed the preceding section of this manual.
- Conduct system check and flame picture adjustments as specified.

INSTALLER: Fill out the appropriate information and apply the high altitude conversion label provided in the high altitude kit to the rating plate on the appliance. See fig. 7.2.2

This appliance has been converted for use at an altitude of _____ .
 Orifice Size: _____ Manifold Press. _____
 Input Btu/Hr. _____ Fuel Type _____
 Date: ___/___/___ Converted by: _____
 Cet appareil a été converti au _____ Injecteur _____
 Pression à la tubulure d'alimentation _____ Débit calorifique _____

Figure 7.2.2 High Altitude Conversion Label.

7.3 Fuel Conversion

NOTE: COMPLETE THE FUEL CONVERSION PROCEDURE BEFORE INSTALLING SURROUND PLATES OR PLACING THE INSERT WITHIN THE FIREPLACE .

WEAR SAFETY GLOVES WHILE WORKING WITHIN THE FIREBOX.

The appliance is shipped from the factory equipped to burn Natural gas. Propane Fuel Conversion Kit #158190 is included with this appliance. Use Fuel Conversion Kit #158191 to convert back to Natural Gas. The kits contain all the necessary components, including labels that must be applied to the insert.

WARNING:

THE CONVERSION KIT IS TO BE INSTALLED BY AN AUTHORIZED JØTUL SERVICE TECHNICIAN IN ACCORDANCE WITH THE MANUFACTURER'S INSTRUCTION AND ALL CODES AND REQUIREMENTS OF THE AUTHORITY HAVING JURISDICTION. FAILURE TO FOLLOW THESE INSTRUCTIONS COULD RESULT IN SERIOUS INJURY OR PROPERTY DAMAGE. THE QUALIFIED AGENCY PERFORMING THIS WORK ASSUMES RESPONSIBILITY FOR THIS CONVERSION.

IN CANADA:

THE CONVERSION SHALL BE CARRIED OUT IN ACCORDANCE WITH THE REQUIREMENTS OF THE PROVINCIAL AUTHORITIES HAVING JURISDICTION AND IN ACCORDANCE WITH THE REQUIREMENTS OF THE CAN1-B149.1 AND .2 INSTALLATION CODE.

LP Conversion Kit

Tools required:

- 1/2" or 13 mm open end wrench or deep-well socket
- Torx T20 driver
- 1/4" nut driver
- 7/16" open end wrench

LP Conversion Kit Contents:

- 1 Regulator Motor labeled for the appropriate fuel
- 3 Regulator Torx screws
- 1 LP Injector - 1.8mm
- Label A - to be completed and applied to the base of the valve compartment
- Label B - apply to the rating plate in the space indicated on the plate.
- Small valve label - apply to valve body
- Conversion instructions

Rating Specifications:	Min./Max Input Rate - BTU/hr.	
SIT Proflame 820 Valve:	NG	LP
0 - 2000 ft.	21,000/38,000	20,000/36,500
2000 - 4500 ft.	19,950/36,950	19,000/35,500

7.3.1 Fuel Conversion Procedure

1. Turn off the gas supply and disconnect electrical power to the appliance.
2. REMOVE THE GLASS FRAME using the Latch Tool. See fig. 1 on page 3.
3. REMOVE THE BURNER - Fig. 7.4
Lift front edge of burner to dislodge from pins of bottom of firebox. Gently wiggle and pull burner forward to disengage from main burner orifice. This is best done with air shutter fully closed or pushed inward.
4. CHANGE THE BURNER INJECTOR: Use a 1/2" or 13 mm open-end wrench or deep-well socket to remove the original burner injector from the brass fitting at the rear of the firebox. See fig. 7.4. Install the injector from the conversion kit and tighten .

CAUTION: Do NOT over tighten the Burner Injector. Over tightening can damage the brass elbow and cause a gas leak!

5. CHANGE THE SINGLE-FUEL PILOT ORIFICE:
Remove the pilot head and original injector from the pilot base. Install the injector from this kit with the flared end down. Secure the base ensuring the head is oriented to project flame to the flame sensor and burner ports.
6. CHANGE THE VARIABLE REGULATOR TOWER on the gas control valve. See fig. 7.6.
 - Remove three screws to remove the original regulator tower, rubber diaphragm and spring.
 - Install the new regulator tower from the kit using the screws provided. Tighten screws securely.
7. Apply the conversion notice labels included in the kit to the appliance where they will be visible to any service technician.
 - Label "A": Apply to the right side compartment adjacent to the Rating Plate.
 - Label "B": Apply to the Rating Plate.
 - Small valve sticker: Apply to valve body.
8. REINSTALL THE BURNER ASSEMBLY.
Tilt the burner back to engage the venturi tube with the burner injector. Check that the burner assembly is level and front legs are securely engaged with the studs in the firebox floor.
9. GAS LEAK CHECK: Use an electronic gas detector or soap solution to test for leaks at the pilot head, regulator tower and all gas line joints. **DO NOT USE AN OPEN FLAME TO CHECK FOR GAS LEAKS.**
10. PRESSURE TEST: Conduct a pressure test of the valve following the guidelines on pages 14-15.
11. BURNER CONFIRMATION: Follow Steps 1 -3 under Initial System Check on page 26 before final assembly of accessories, log set, and surround components.

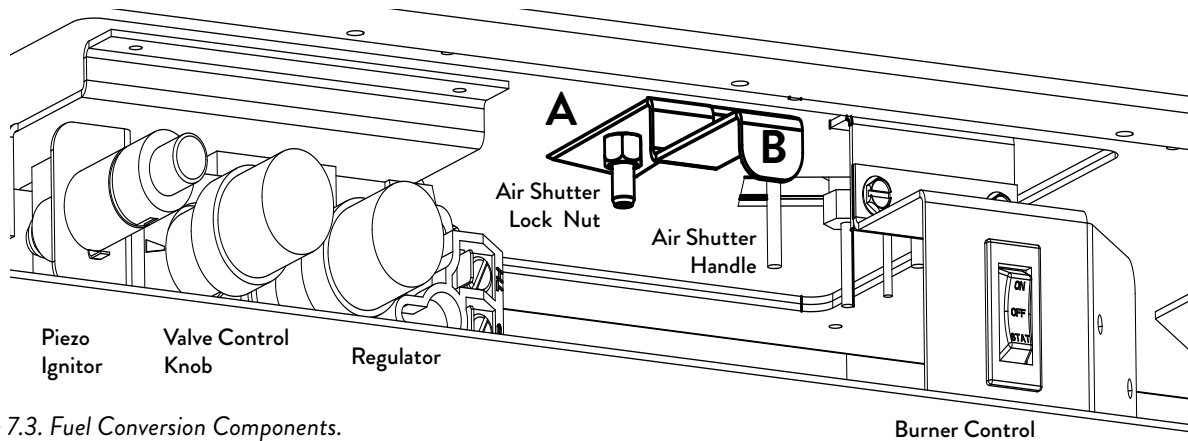

Figure 7.3. Fuel Conversion Components.

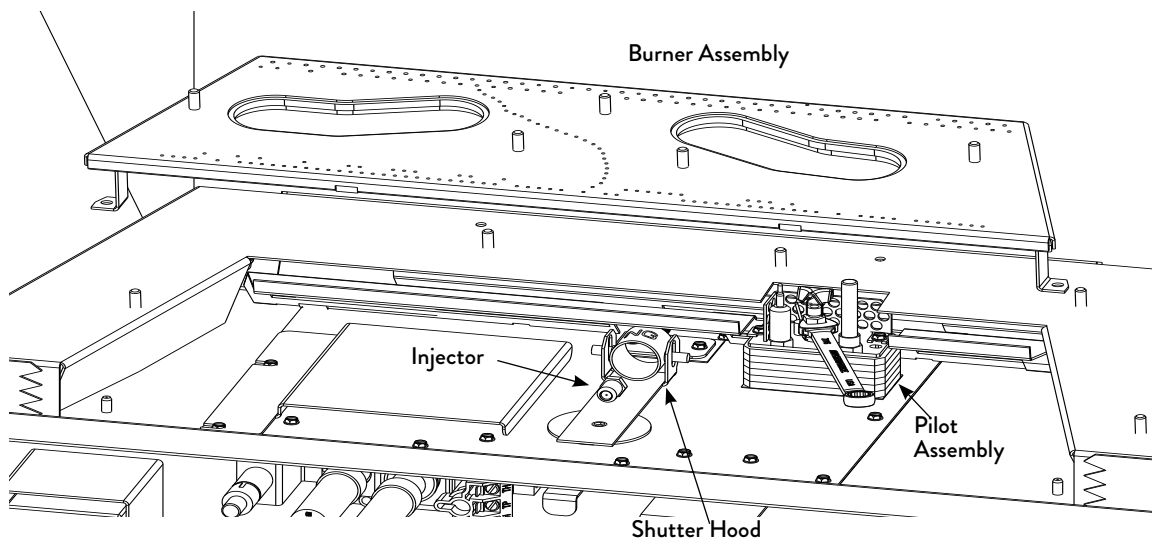

Figure 7.4. Burner and injector removal.

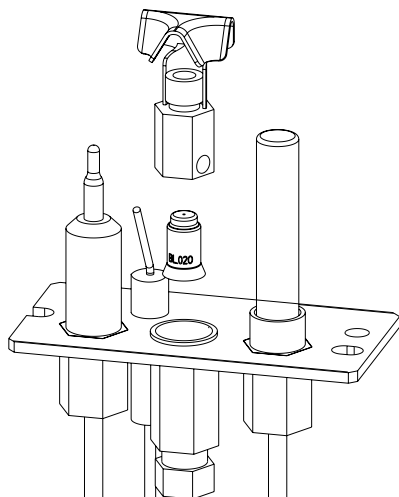

Figure 7.5. Pilot Orifice conversion.

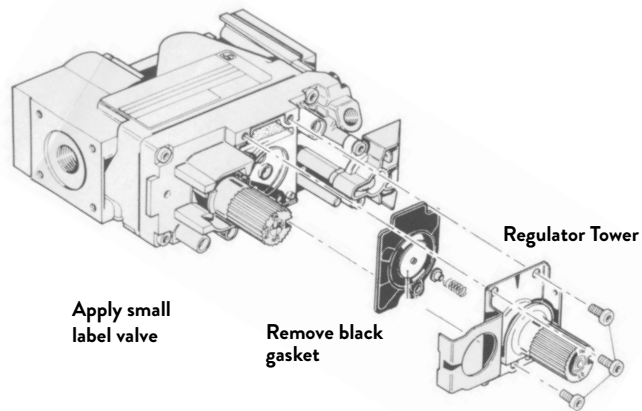

Figure 7.6. Regulator conversion.

7.4 Optional Controls Installation

7.4.1 Remote Control Kit #224910

Contents:

- Remote Receiver / battery box
- Remote Transmitter
- 4, AA Receiver batteries
- 2, AAA Transmitter batteries

1. Insert the AA batteries into the Receiver box.
2. Insert the AAA batteries into the Remote Transmitter.
3. Remove the protective film from the Velcro® adhesive pad on the Receiver box and set the box on the floor within the steel housing to the left of the gas control valve. See fig. 10.1, #14-15, page 30.
4. Remove the fireplace Burner Control face plate(#53, pg 33) with removal of the upper two #8 hex head screws.
5. Connect the Receiver leads to the valve terminal block as shown in fig. 7.7.

See the Operation Instructions included with the kit for complete information regarding features and use of the remote transmitter and receiver units.

7.4.2 Wall Thermostat #750003

- Use only a 750 millivolt, DC two-wire circuit wall thermostat. Follow the manufacturer's installation instructions.
- Use a minimum 16 gauge wire up to a maximum length of 35 feet for connection to the fireplace.
- The thermostat should be placed in the same room as the heater, typically 5 feet off the floor. Avoid drafty areas or any area that may affect the accuracy of the thermostat.

Thermostat Connection

- Remove the fireplace Burner Control face plate (#53, pg 33) with removal of the upper two #8 hex head screws.
- Connect each thermostat lead to either of the two open terminal block connectors located on the back of the control panel. Do not overtighten the connections. See fig. 7.7.
- At the thermostat, connect the leads to the two connection screws on the thermostat base plate according to the manufacturer's instructions.

Thermostatic Operation

Follow the accessory manufacturer's operation instructions.

1. Set the fireplace burner mode switch to the STAT position for either remote or wall thermostat control.
2. Light the pilot following the instructions found in this manual and on the appliance rating plate. When the pilot is lit, the burner will respond to calls for heat either thermostatically or by remote transmitter.

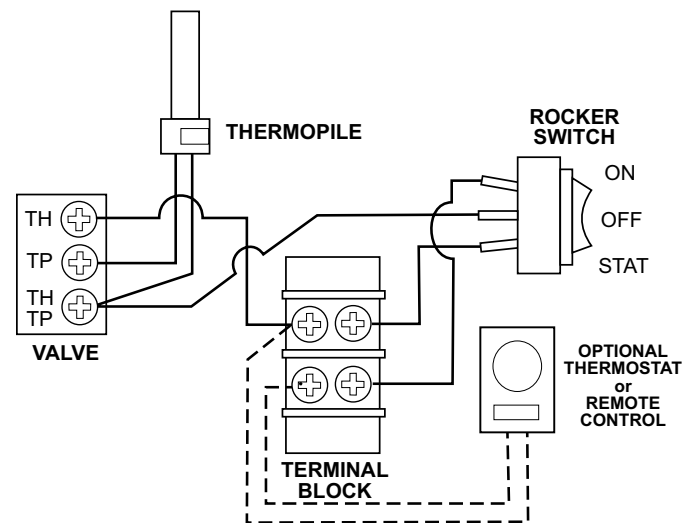

Figure 7.7. Accessory control wiring diagram.

7.4 Backer Plate Installation

Both the Standard and Trimable Backer Plates incorporate four hanger hooks (B) that engage with the *outer* slots (C) through the *back* of the firebox brackets. Note the small identifying hole above each “C” slot. See fig. 7.35.

Tools Required

- gloves and eye protection
- zip wheel or other sheet metal cutting tool for Trimmable plate installation
- Phillips head screwdriver

IMPORTANT:

DO NOT PLACE THE INSERT IN THE FINAL POSITION UNTIL THE BACKER PLATE IS INSTALLED.

THE FIREBOX MUST BE SET OUT OF THE FIREPLACE ENOUGH TO INSTALL THE BACKERPLATE

COMPLETE THE GAS, VENT CONNECTION, AND FUEL CONVERSION BEFORE INSTALLING THE BACKER PLATE.

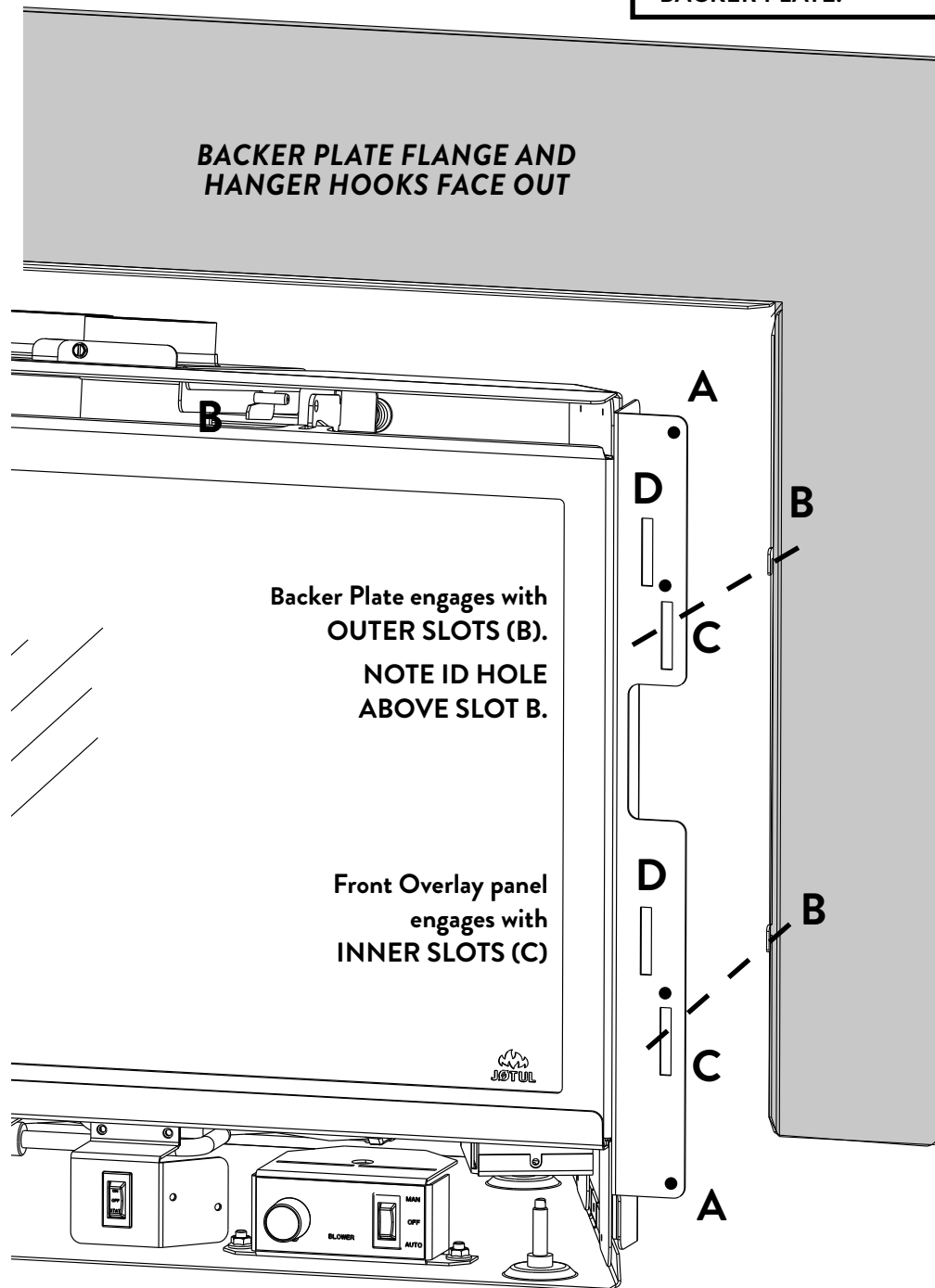

Figure 7.8

Loosen the surround spacer screws (A).

Backer Plate hooks (B) engage slots (C) from behind.

The front Overlay engages with slots (D) from the front.

7.6 Optional Firebox Panels

158131 Black Reflective Glass

- Rear Panel - 226461
- Right Side Panel - 226462
- Left Side Panel - 226463
- Side Panel Stand-off (2) - 226643
- Cotton Gloves - 138765
- Retainer Tabs (2) - 224727
- Nuts (2) - 117968

158133 Black Fluted Panels

- Rear Panel - 226694
- Left Side Panel - 226695
- Right Side Panel - 226696
- Baffle Panel - 226697

158132 Traditional Red Brick

- Rear Panel - 226624
- Left Side Panel - 226625
- Right Side Panel - 226626
- Baffle Panel - 226627

158195 Brownstone Brick

- Rear Panel - 226698
- Left Side Panel - 226699
- Right Side Panel - 226700
- Baffle Panel - 226701

Tools Required:

- Pliers or flat screwdriver
- Safety glasses
- Assistant

These instructions apply to all panel kits, except as noted. Inspect each panel and contact your dealer if any damage is found.

THE PANELS ARE VERY FRAGILE. HANDLE GINGERLY. BE CAREFUL TO AVOID DAMAGE TO EDGES OR CORNERS BY CONTACT WITH OTHER PARTS OF THE FIREPLACE.

GLASS PANEL NOTES:
USE THE COTTON GLOVES PROVIDED TO HANDLE THE GLASS PANELS AND PREVENT FINGERPRINT STAINS. SKIN OIL RESIDUE IS DIFFICULT TO REMOVE FROM THE GLASS SURFACES.

IMPORTANT!
INSTALL EACH GLASS PANEL ORIENTED WITH THE TEXTURED SIDE FACING AGAINST THE FIREBOX WALLS.

1. Install the Side Panel Retainer Tabs - Glass Kit Only

Panel retainer tabs (fig. 7.9) are installed at the upper front corners of the firebox walls. Hand start the nuts over the tabs as shown.

2. Install the Rear Panel - all kits

The panel simply rests on the rear burner skirt, flat against the back of the firebox with the beveled edge (brick and stone kits) facing up. The side panels will lock the rear panel in place as they are installed. Fig. 7.10.

3. Install the Side & Baffle Panels

• Brick or Fluted Kits

Set left panel on the burner skirt directly against the firebox wall.

Place the left edge of the baffle piece on top of panel. Hold flush to top of firebox and install right panel. Retainer tabs are not necessary for this installation.

• Glass Kit only (fig. 7.11)

Set the steel Stand-off Plate (B) on the burner skirt between the wall and the glass Side Panel (C). Orient each Side Panel, *textured side-in*, on the burner skirt against the Stand-off Plate.

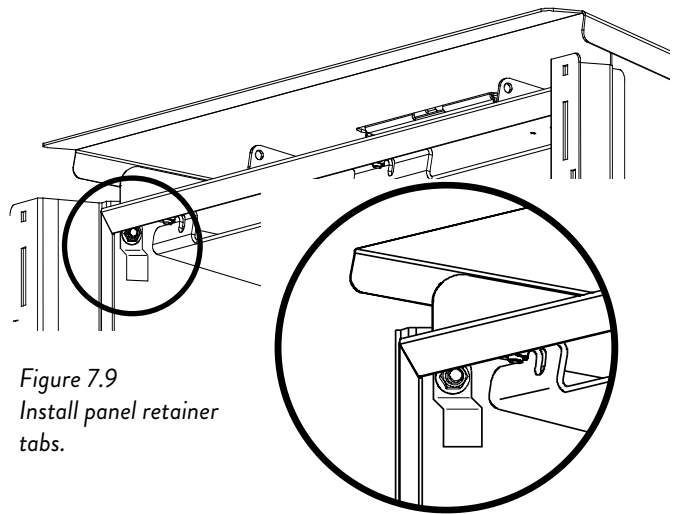

Figure 7.9
Install panel retainer tabs.

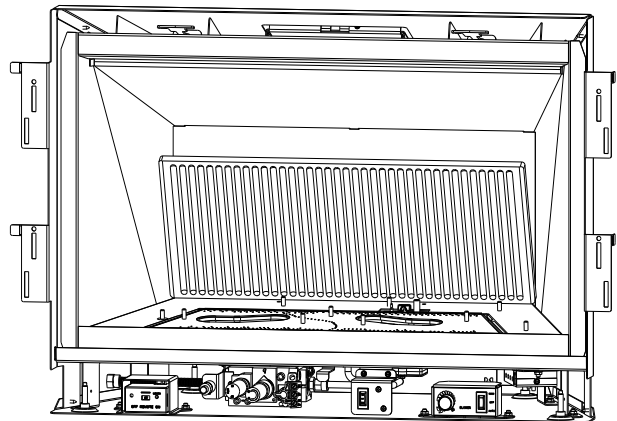

Figure 7.10 Install rear panel. Fluted panel shown.

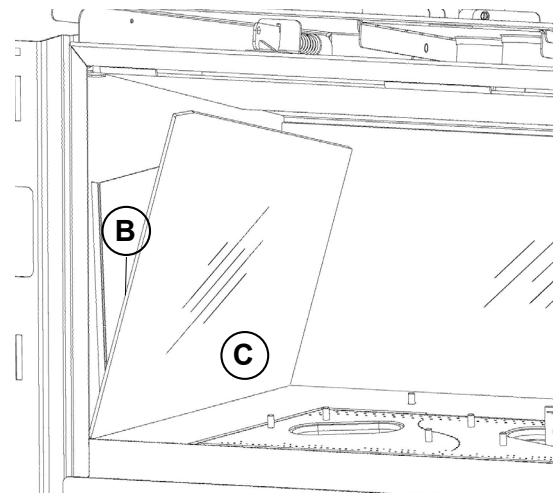

Fig. 7.11. Glass panel installation.

- Using a 10mm wrench, tighten nuts for retainer tabs to hold panels into place.



TIGHTEN TABS UNTIL PANELS ARE SECURE. OVER-TIGHTENING MAY DAMAGE THE GLASS.



Watch this instructional video to install the traditional logset!

7.7 Install the Traditional Log Set

NOTE: Install optional Firebox Panels before installing the Log Set.

Install the log set in the order presented here.

Fig. 7.20 shows the final arrangement. ID numbers corresponding to those below are imprinted on the back of each log.

Use the Ember Stones from the Miscellaneous Hardware bag to simulate glowing embers. Carefully position these as shown in Figs. 14 and 20. Avoid completely covering the burner porting holes.

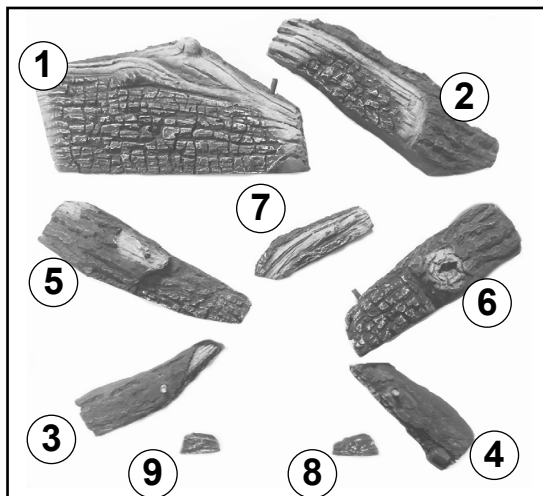

Figure 7.12a

GI 645 DV MV Traditional Log Set	158153
#1 Left Rear Log	226702
#2 Right Rear Log	226703
#3 Left Burner Log	226704
#4 Right Burner Log	226705
#5 Left Cross Log	226706
#6 Right Cross Log	226707
#7 Center Cross Log	226708
#8 Right Small Log	226709
#9 Left Small Log	226710
Ember Stones, 4 oz.	

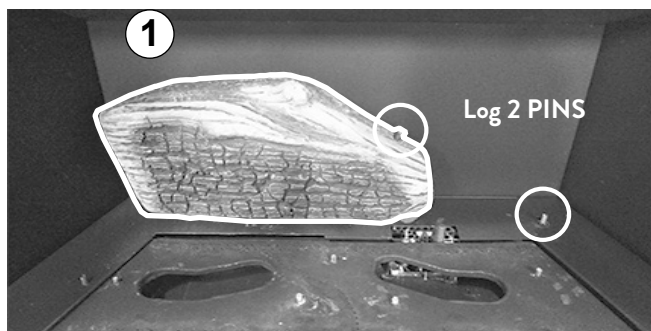

Figure 7.12b. Engage the Left Rear Log #1 with the two steel pins at the back of the steel Burner Skirt.

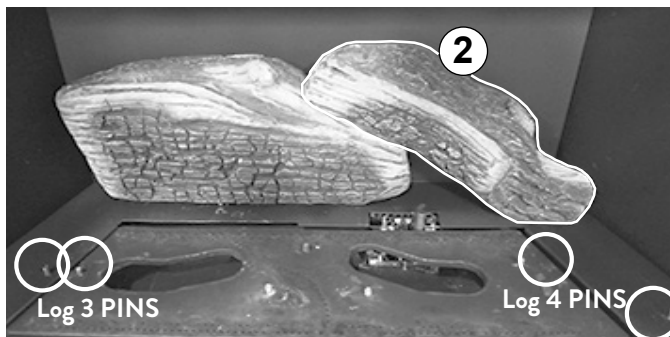

Figure 7.13. Engage Right Rear Log #2 with the 2 pins indicated in fig. 7.12 on #1 and the burner skirt.

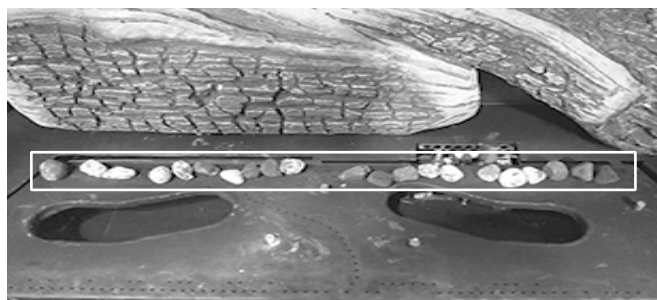

Figure 7.14. Position the first line of embers onto burner. Be careful to avoid obstructing the pilot and burner carry-over ports shown in Fig. 7.21.

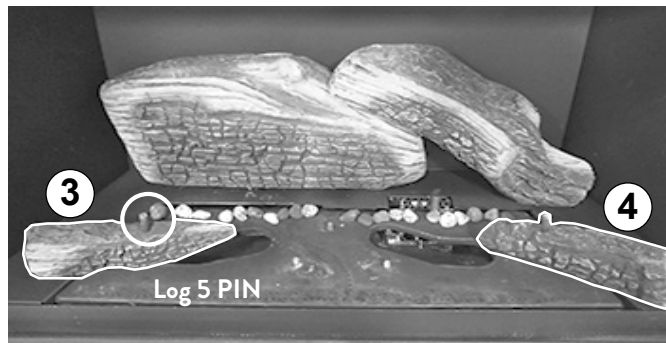

Figure 7.15. Engage the holes in the underside of Left Burner Log #3 & Right Burner Log #4 with the matching pins on the burner plate shown in fig. 7.13.

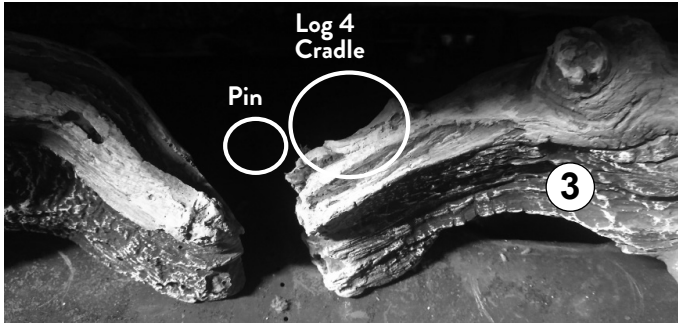

Figure 7.27a Cradle and Pin on Right Burner Log #3 for Center Cross Log #4



Figure 7.19. Position Right Small Log #8 and Left Small Log #9 in front of logs #5 & 6. Do not cover burner ports.



Figure 7.16. Engage holes in the underside of Left Cross Log #5 with the pin on Log #3 and the corresponding pin on the steel burner shown in fig. 7.15.



Figure 7.20 Position Burner Embers in row on burner. Be careful to avoid obstructing the pilot and burner carry-over ports shown in Fig. 7.21.

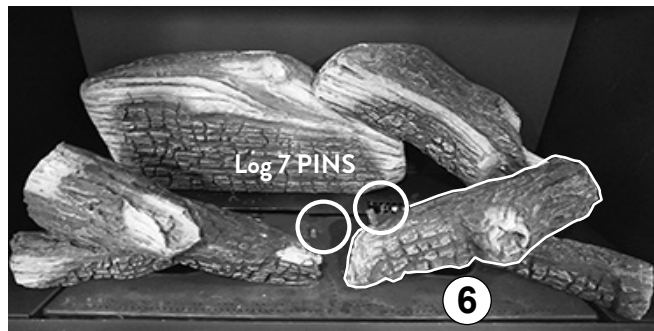

Figure 7.17. Engage holes in the underside of Right Burner Log #6 with the matching pins on Log #4 and burner plate shown in fig. 7.15.

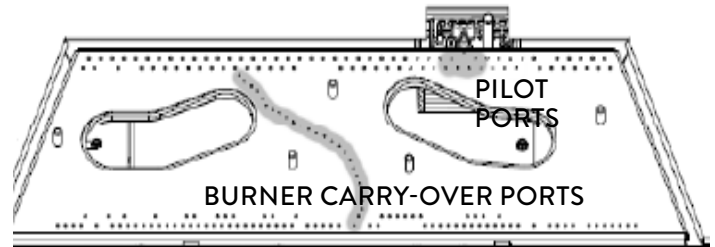
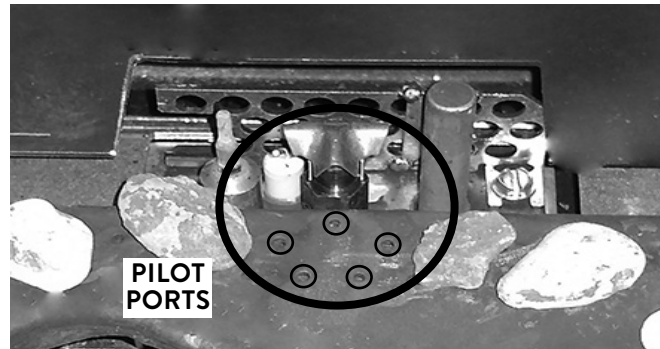

Figure 7.21. Burner and Pilot carry-over ports are tinted..

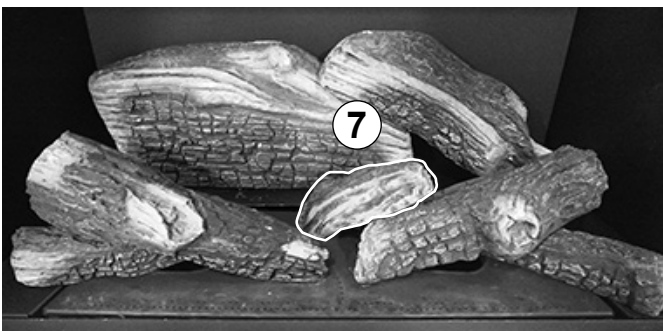

Figure 7.18. Engage the holes in the underside of the Center Cross Log #7 with the pin on log #6 and middle of the burner plate shown in fig. 17.

WARNING: FREQUENTLY INSPECT THE PILOT AREA AND KEEP IT CLEAR OF MISPLACED LOGS OR EMBER STONES. DO NOT ALLOW ANY MATERIAL TO OBSTRUCT PILOT OR BURNER CARRY-OVER PORTS.



Watch this instructional video to install the beachfire logset!

7.8 Install the Beachfire Log Set

NOTE: Install firebox panel accessories before installing the Log Set.

Install the log set in the order presented here. Note that each log engages with with corresponding pins as indicated in the photos below. Fig. 7.30 shows the final arrangement. Use the rock wool fibers from the Miscellaneous Hardware bag to simulate glowing embers.

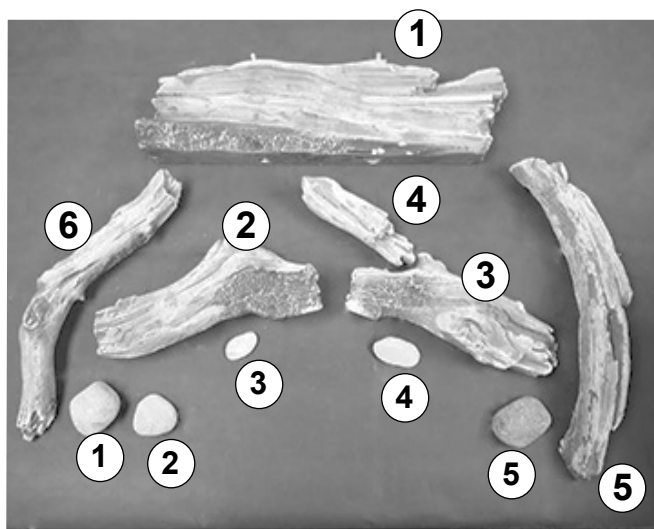

Figure 7.22

GI 645 DV MV Beach Fire Log Set	158154
#1 Rear Log	226711
#2 Left Burner Log	226712
#3 Right Burner Log	226713
#4 Center Cross Log	226714
#5 Right Top Cross Log	226715
#6 Left Top Cross Log	226716

Beach Fire Rocks - see engraved identification numbers

#1 Left Skirt	226717
#2 Left Burner	226718
#3 Center Burner	226719
#4 Right Burner	226720
#5 Right Skirt	226721

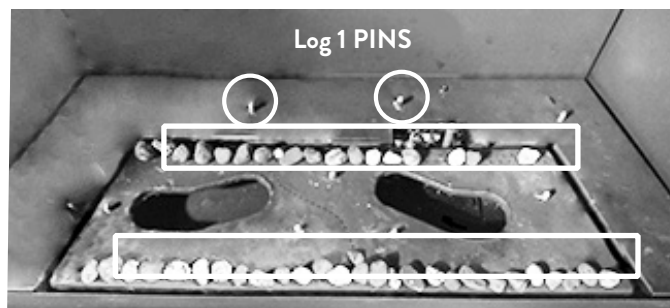

Figure 7.23 Position 2 lines of embers onto burner. Be careful to avoid obstructing the pilot and burner carry-over ports shown in Fig. 7.32.

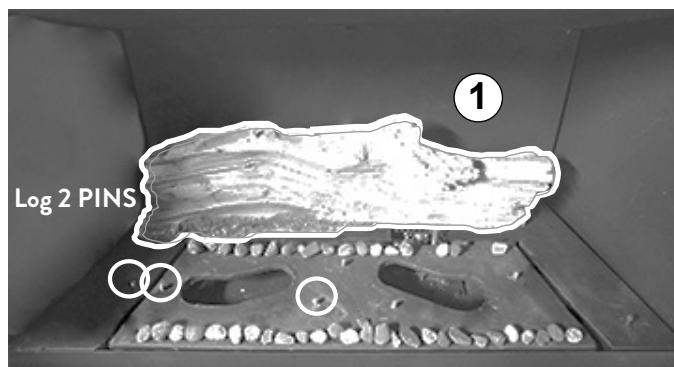

Figure 7.24. Engage the Rear Log #1 with the left and center pins indicated on fig. 7.23 at the back of the steel Burner Skirt.

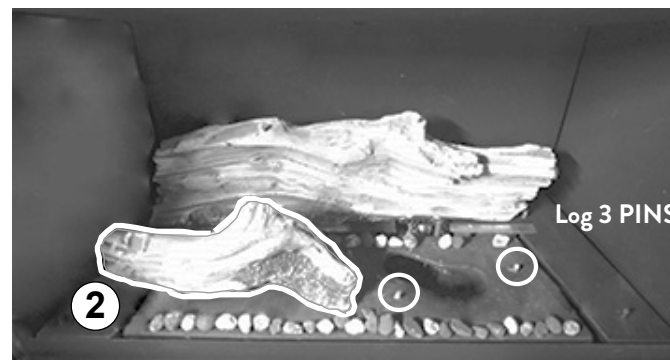

Figure 7.25 Engage the Left Burner Log #2 with the three steel pins indicated on fig. 7.24

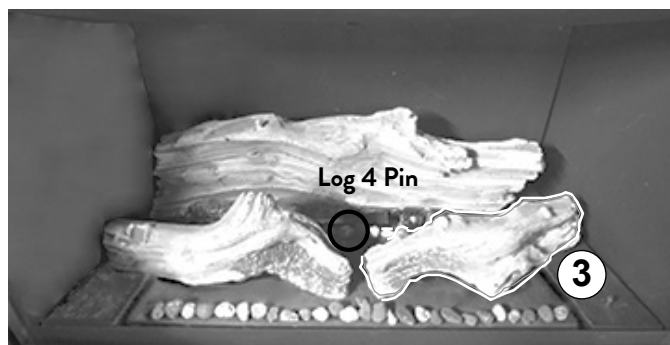

Figure 7.26. Engage the Right Burner Log #3 with the right and center pins on the burner plate indicated on fig. 7.25.

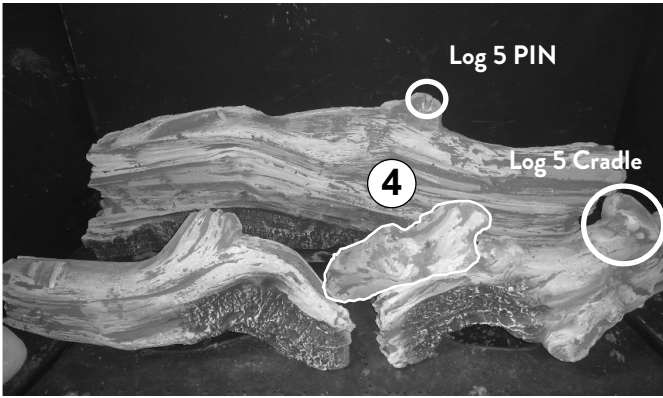

Figure 7.27 Engage matching notches in the underside of Center Cross Log #4 with the corresponding cradle on Log #3 and the pin on the Burner as indicated in fig. 7.26 and 7.26a.

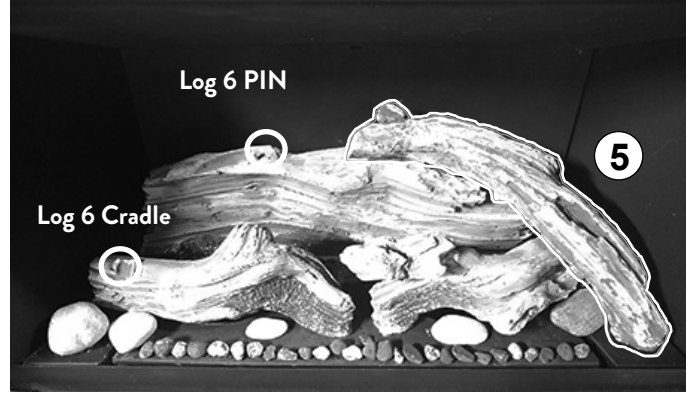

Figure 7.30 Engage matching notches in the underside of the Right Top Cross Log #5 with the corresponding notches on Log #1, #3, and the Burner Skirt as indicated in fig. 7.27

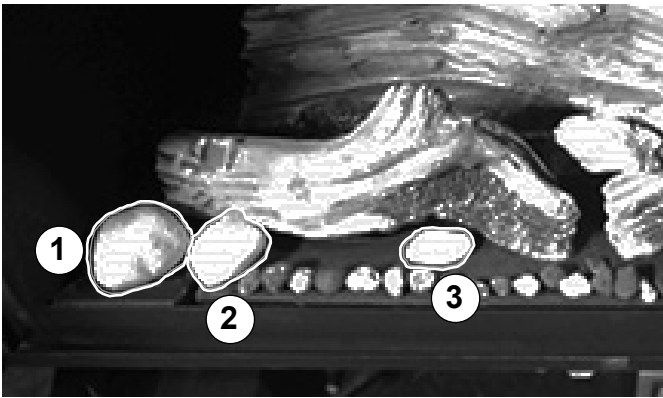

Figure 7.28 Place #1 Left Beach Fire Rock and #2 Left Burner Rock under Front Left Log #2. Place #3 Center Burner Rock with the angle facing in towards center of log #2. Make sure not to block burner ports.



Figure 7.31. Engage matching notches in the underside of the Left Top Cross Log #6 with the corresponding pin on Log #1 and cradle on Log #2, as indicated in fig. 7.30

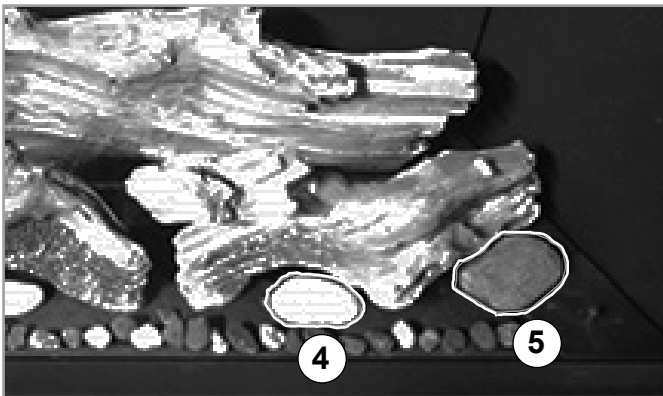

Figure 7.29 Place #4 Right Beach Fire Rock and #5 under Right Front Log #3. Make sure not to block burner ports.

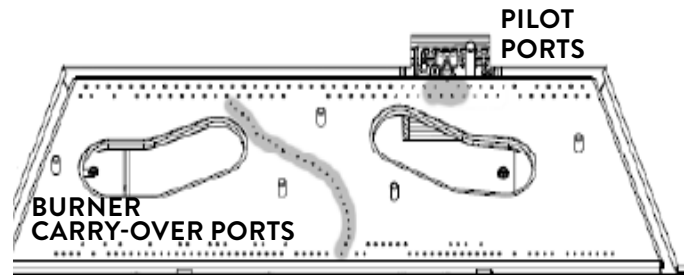
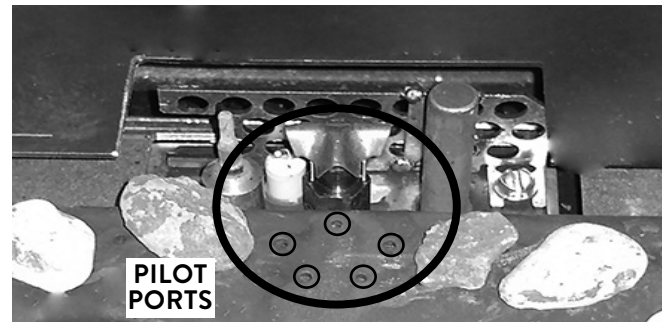
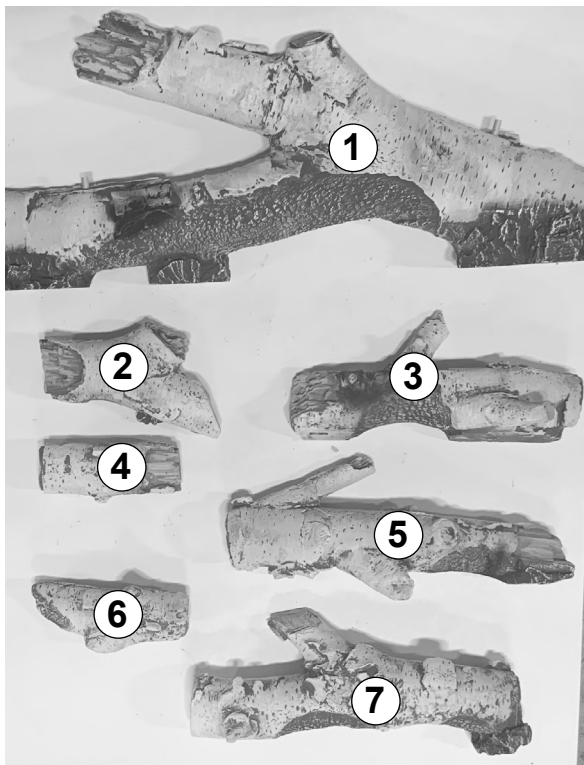

Figure 7.32 Keep Burner and Pilot carry-over ports clear.

7.9 Install the Birch Log Set

NOTE: Install firebox panel accessories before installing the Log Set.

Install the log set in the order presented here. Note that each log engages with with corresponding pins as indicated in the photos below. Fig. 7.40 shows the final arrangement. Use the rock wool fibers from the Miscellaneous Hardware bag to simulate glowing embers.



GI 645 DV MV Birch Log Set

#1 Rear Log	158352
#2 Left Side Log	227052
#3 Right Side Log	227053
#4 Upper Log	227054
#5 Left Cross Log	227055
#6 Middle Cross Log	227056
#7 Right Cross Log	227058



Figure 7.34. Engage Left Side Log #2 with the pins on the left side of the burner indicated in fig. 7.33.



Figure 7.35. Engage Right Side Log #3 with the burner pins indicated in fig. 7.34.

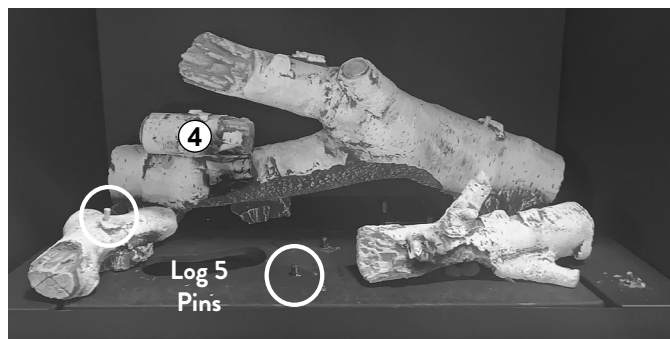

Figure 7.36. Engage hole in the underside of Upper Log #4 with the corresponding pin on the Rear Log indicated in fig. 7.35.

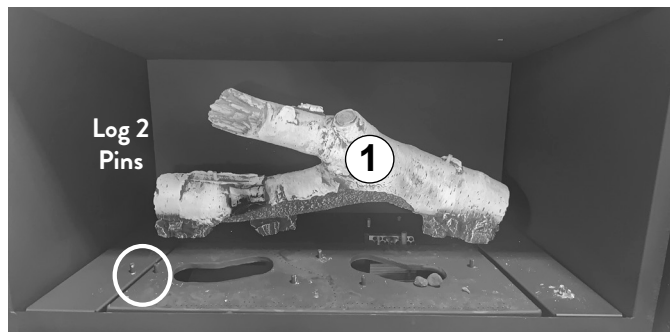

Figure 7.33. Engage the Rear Log #1 with the two steel pegs located on rear burner skirt.

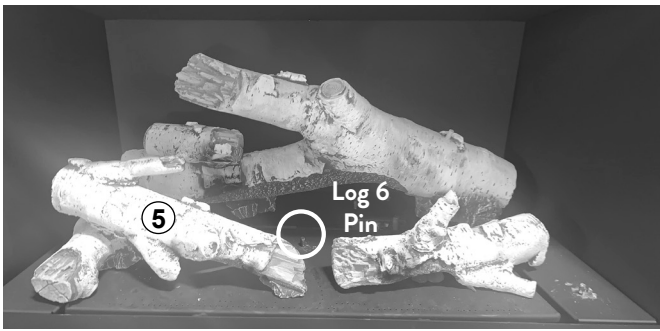

Figure 7.37. Engage the underside of Left Cross Log #5 with burner and log pins indicated in fig. 7.36.

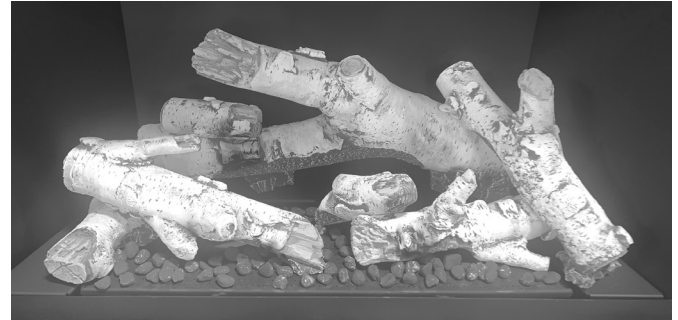

Figure 7.40. Place Burner Ember Stones (Included in Misc. Kit) in one even layer over steel burner. Be careful not to block the pilot area or burner carry-over ports.



Figure 7.38. Engage matching notches in the underside of the Middle Cross Log #6 with the corresponding burner pin indicated in fig. 7.37 and matching notch on Log #3.

CAUTION: Do NOT lay Middle Cross Log #6 flat on the burner. This may block the burner carry-over ports.

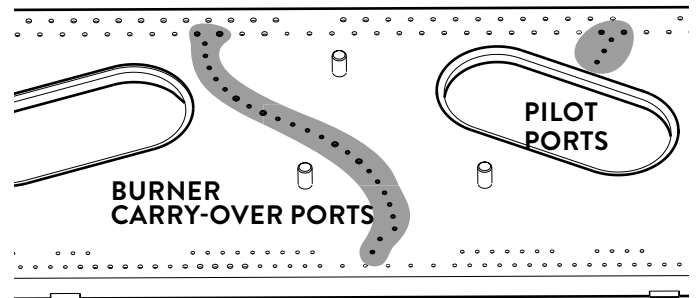

Figure 7.41. Keep Burner and Pilot carry-over ports clear.



Figure 7.39. Engage Right Cross Log #7 on the burner pin and the pin on Rear Log #1 indicated in fig. 7.38.

7.10 Mantle Heat Shield

Installation

The Mantle Heat Shield slides over the Backer Plate as shown in Fig. 7.42

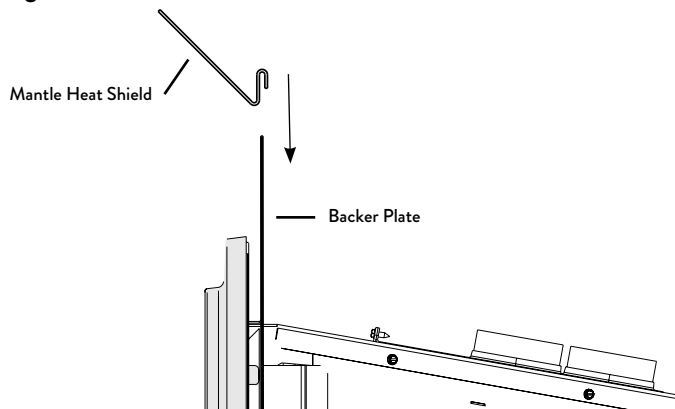

Figure 7.42 Lower the Mantle Heat Shield onto the Backer Plate

⚠ WARNING! See Fig. 7.43.

- A MINIMUM 1/2" (13 mm) AIR SPACE MUST BE MAINTAINED BETWEEN THE FRONT OVERLAY ASSEMBLY AND THE BACKER PLATE OR FIREPLACE FACE. THIS AIR SPACE IS AUTOMATICALLY MAINTAINED BY THE BACKER PLATE HOOKS WHICH ACT AS STAND-OFFS. IF A BACKER PLATE IS NOT USED, THE AIR SPACE MUST BE CREATED BY THE TWO SCREWS ON EACH FIREBOX HANGER BRACKET. SEE DETAIL VIEW BELOW.
- DO NOT MODIFY THE HANGER BRACKET POSITIONS OR REDUCE THE OVERLAY AIR SPACE IN ANY WAY. DOING SO MAY OVERHEAT THE APPLIANCE AND VOID THE WARRANTY.

7.10 Surround Overlay Assembly

Both the Cast Iron and the Steel Surround Overlays are shipped fully assembled, including the integrated Safety Barrier Screen.

Installation

The Cast Iron Overlay assembly is heavy - assistance will be helpful. Handle the enameled assembly carefully to avoid accidental damage.

The Overlay hanger brackets engage with the *inner slots (D)* through the *front* of the firebox mounting brackets. See figs. 7.8 and 7.43.

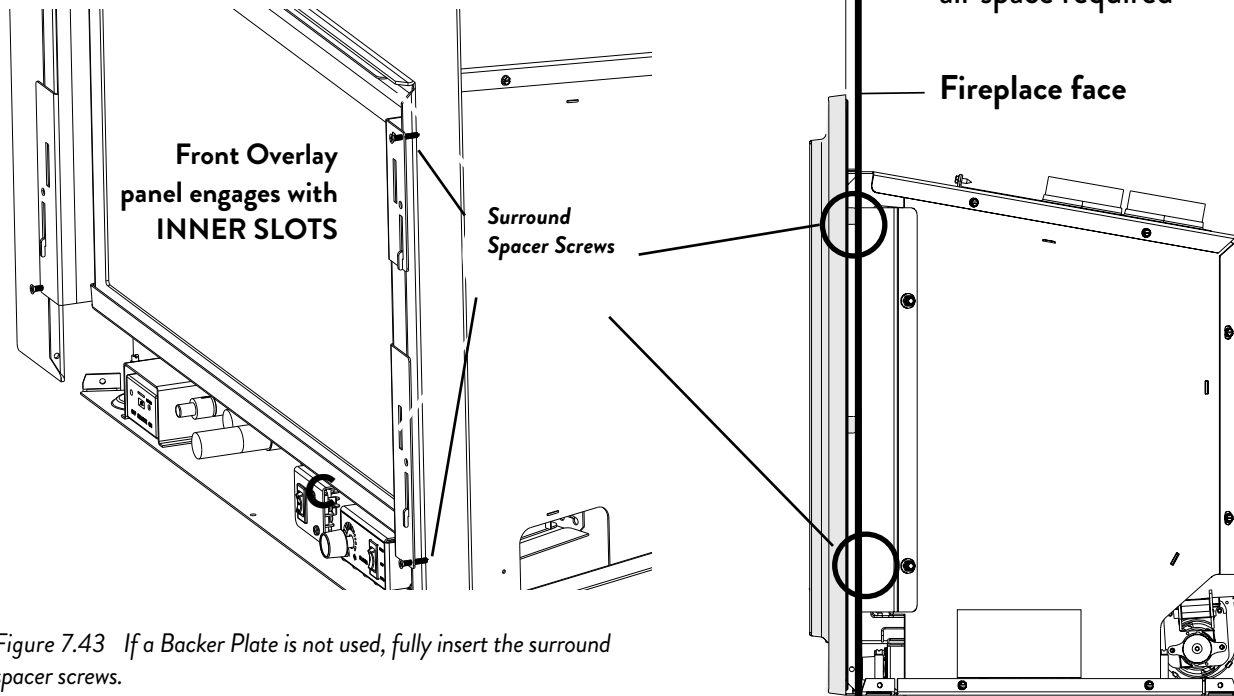

Figure 7.43 If a Backer Plate is not used, fully insert the surround spacer screws.

8.0 Operation

WARNING:

READ AND UNDERSTAND ALL OPERATING INSTRUCTIONS BEFORE ATTEMPTING TO OPERATE THIS APPLIANCE. DO NOT ALLOW ANYONE TO OPERATE THIS APPLIANCE WHO HAS NOT READ AND UNDERSTOOD THESE INSTRUCTIONS. KEEP THE REMOTE CONTROL TRANSMITTER WHERE CHILDREN CANNOT REACH IT.

WARNING:

SEVERE INJURY. THIS APPLIANCE CAN BE SET TO OPERATE THERMOSTATICALLY. BE AWARE THAT THE APPLIANCE MAY BE VERY HOT EVEN WHEN THE BURNER IS NOT APPARENTLY OPERATING. KEEP CHILDREN AWAY FROM THE APPLIANCE.

- During the first few hours of operation, it is common to detect some smoke and odor resulting from the high-temperature paint curing. This condition is temporary and may be alleviated by opening windows and using a fan to exhaust air out of the area.
- Condensation will develop on the glass each time the burner ignites from a cold start. This “fog” will dissipate as the glass heats. Leaving the pilot on during the heating season will minimize condensation.
- **IMPORTANT:** It will be necessary to clean the glass after the first few fires. A white powdery residue will be evident which results from the burner media curing. Use a non-abrasive household glass cleaner or warm water. **IF THE GLASS IS NOT CLEANED, THIS RESIDUE CAN CAUSE THE GLASS TO BECOME PERMANENTLY ETCHED. DO NOT USE AMMONIA-BASED CLEANERS.**
- **NOTE GI 645 DV MV MODEL:** This appliance can be operated with a continuously burning pilot flame for up to seven days after which the flame will automatically extinguish if there has been no call for heat within that time period. Relight the pilot manually following the instructions on the back cover and rating plate.
- Keep the control compartments free of dust and debris. Always keep the appliance area clear and free from combustible materials, or flammable liquids.
- Exercise caution when using household products containing combustible vapors when the pilot is burning.
- **CAUTION: DO NOT OPERATE THIS APPLIANCE WITH THE GLASS PANEL REMOVED, CRACKED OR BROKEN. REPLACEMENT OF THE GLASS SHOULD BE DONE BY A LICENSED OR QUALIFIED SERVICE PERSON. USE ONLY REPLACEMENT GLASS PROVIDED BY YOUR AUTHORIZED JØTUL DEALER. DO NOT SUBSTITUTE ANY OTHER TYPE OF GLASS.**

8.1 Initial System Check and General Operation

Service should only be performed by a licensed gas service technician. If these instructions are not followed exactly, a fire, explosion, or production of carbon monoxide may result causing property damage, personal injury or loss of life.

1. Initial System Purge:

Open the gas supply line valve. Make sure glass frame is removed prior to system purge. When lighting the appliance for the first time, or after a long period of unuse, it will take a few moments to clear the gas line of air.

2. Light the Pilot:

Once this purge is complete, light the pilot following the lighting instructions located on the rating plate and back cover of this manual.

All three pilot flames should project out of the pilot hood. The flames should be blueish-yellow in color and extend approximately 1” over to the burner ports, thermopile, and thermocouple. Each flame should be strong and steady - not fluttering or lifting. It is important that the pilot flame fully engulf the upper 1/4” of the thermocouple and thermopile. See Fig. 8.2.

The pilot flames may be adjusted if necessary using the adjustment screw located on the gas valve body, Fig. 7.2.1, page 15. Pilot adjustments should only be made by a qualified gas technician.

BURNER

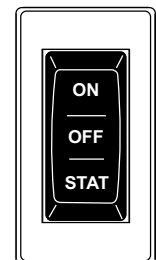

Figure 8.1.

3. Burner Light-off Timing: This test confirms correct pilot-to-burner ignition. When lighting the pilot for the first time, or in a cold flue, it may be necessary to allow the pilot to burn for 10-15 minutes to establish draft before main burner ignition.

A) Set the gas valve regulator to LOW.

B) **Cold Start:** Turn the burner switch to ON and countdown in seconds the time for full burner ignition; that is, all burner ports are projecting flame. Full burner ignition should occur within 4 seconds of switching ON. See troubleshooting guide if greater than 4 seconds.

Reinstall the glass frame prior to hot start testing.

C) **Hot Start:** After the burner has been on for 5-10 minutes, turn it off and wait 2 minutes. Turn it on and again record the time for full ignition. Full burner ignition should occur within 4 seconds of switching ON. Test condition with burner on low. See troubleshooting guide if greater than 4 seconds.

Adjust the valve Regulator knob to control fire intensity and heat output.

4. STAT position:

Set the Burner Switch to STAT for optional remote or wall thermostatic control. Follow the instructions of the thermostat manufacturer.

5. Blower Operation:

Refer to section 8.2 for blower operation.

Flame Picture / Air Shutter Adjustment**WARNING:**

AIR SHUTTER ADJUSTMENTS SHOULD ONLY BE PERFORMED BY A QUALIFIED PROFESSIONAL SERVICE TECHNICIAN.

The volume of air supplied to the burner is regulated by the primary air shutter, located under the firebox at the center of the valve compartment. See fig. 8.3 The factory air shutter setting is 1/2 open and will not require adjustment for most installations. Air volume can be adjusted if necessary to improve the flame picture or to correct poor combustion.

The burner is very sensitive to air supply volume. Make air adjustments in 1/8" - 1/4" increments. Wait a few minutes to observe the flame pattern changes before making subsequent adjustments. Repeat the process until a satisfactory flame picture is achieved.

Insufficient combustion air will promote inefficient combustion resulting in very long yellow flames and soot. Sooting produces black deposits on the logs, on the firebox walls, and potentially on the flue termination cap.

Very blue, transparent, or weak "anemic" flames are indications of too much air which, although efficient, are not very attractive.

Generally, propane fuel will require a less restricted air shutter setting than will natural gas.

- Loosen the shutter handle lock nut.
- PUSH the shutter handle IN to DECREASE air volume.
- PULL the handle OUT to INCREASE air volume.
- Tighten the lock nut after shutter adjustment.

NO SMOKE OR SOOT SHOULD BE EVIDENT.

Confirm correct log placement if any soot or smoke appears. If the conditions persists, adjust the air shutter to increase air volume and promote efficient combustion.

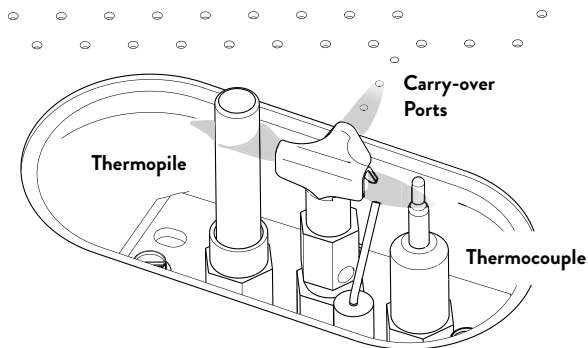

Figure 8.2. Correct pilot flame appearance.

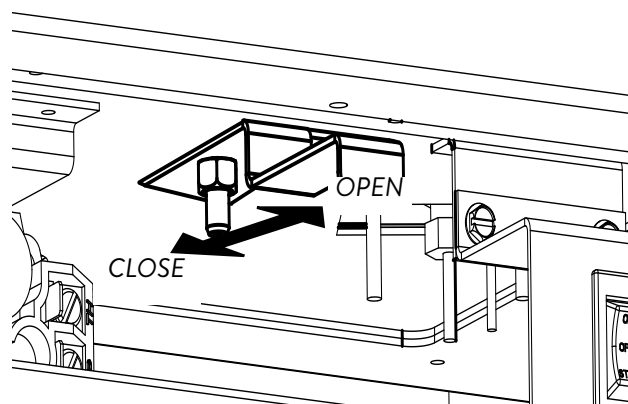

Figure 8.3. Air Shutter adjustment

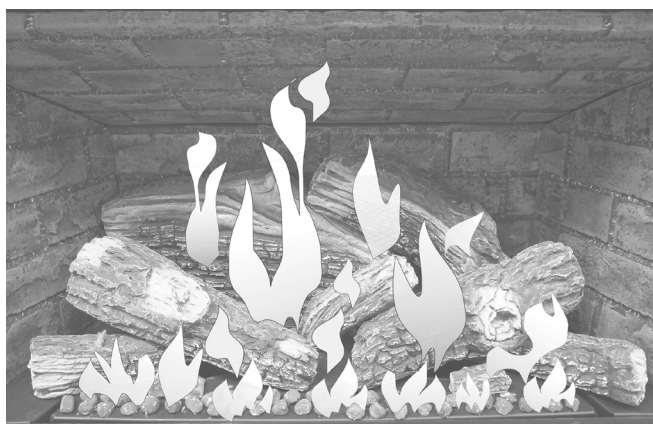

Figure 8.4. Correct flame picture.

8.2 Blower Operation

Use the following procedures for blower operation:

MANUAL OPERATION:

In the Manual switch position, the blower will power on regardless of firebox temperature. Blower speed is controlled by the adjustment knob on the switch panel. Under Manual operation, the blower will remain ON regardless of burner operation until switched to AUTO or OFF.

AUTOMATIC OPERATION:

The blower will power ON when its thermostat (snapstat) reaches 140°F (60°C). When the burner is shut off, the blower will continue to operate until the firebox temperature cools below 120°F.

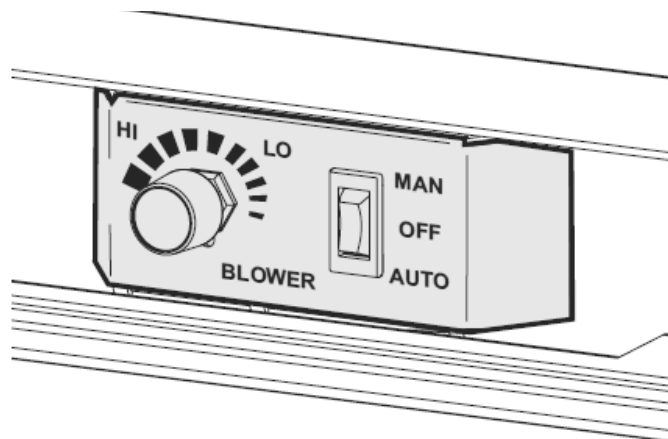

Figure 8.5. Blower controls.

8.3 Thermostatic or Remote Control

See the accessory manufacturer's operation instructions.

1. Set the fireplace burner mode switch to the STAT position for remote control.
2. Light the pilot following the instructions found in this manual and on the appliance rating plate. When the pilot is lit, the burner will respond to calls for heat either thermostatically or by remote transmitter.

GI 645 DV MV PILOT LIMIT NOTE:

The pilot will automatically extinguish after 7 days if there is no call for heat during that period. The pilot light will then need to be relit following the lighting instructions in this manual or on the rating plate.

9.0 Maintenance

⚠ CAUTION:

ALWAYS DISCONNECT ELECTRICAL POWER WHEN SERVICING THIS APPLIANCE.

LABEL ALL WIRES PRIOR TO DISCONNECTION WHEN SERVICING THE CONTROLS. WIRING ERRORS CAN CAUSE IMPROPER AND DANGEROUS OPERATION. ALWAYS VERIFY PROPER OPERATION AFTER SERVICING THE APPLIANCE.

With proper care and maintenance, your appliance will provide you with years of enjoyment. If you experience any problem with your fireplace insert, contact your Jøtul Authorized Dealer for assistance.

KEEP THIS MANUAL FOR REFERENCE AND MAKE IT AVAILABLE TO ANYONE USING OR SERVICING THE INSERT.

This appliance and venting system should be inspected before use and at least annually by a qualified service technician

9.1 General Cleaning

- Vacuum the controls area under the firebox at least monthly or more frequently if pet hair is in the environment. Always keep the appliance area clear and free from combustible materials, such as gasoline and other flammable liquids. **ALWAYS BE SURE THE BURNER AND FIREBOX ARE COLD** before using a vacuum cleaner.
- The firebox should be vacuumed at least annually and more frequently if pets are in the house. Use a flexible attachment to reach into the valve compartment and blower area.
- Use a soft brush attachment to vacuum the log set.
- Inspect the pilot assembly for corrosion and have any damaged components replaced by a qualified service technician. Remove any debris from burner ports, particularly the pilot carry-over ports. See fig. 7.21, page 21.

9.2 Gasket Inspection

- Inspect the glass gasket annually. Examine the gasket for signs of deterioration or stiffness and confirm that the gasket maintains a positive seal. This is important to prevent combustion gases escaping into the room. Replace the gasket if necessary. Refer to the replacement parts list in the illustrated part list.

9.3 Glass Care

Moisture condensation is a normal occurrence with gas appliances and particulate accumulation may appear on the inside surface to the glass. Use a dampened, soft cloth to clean the glass and polish with a dry, soft towel.

Specially-formulated ceramic glass cleaner may also be used.

⚠ DO NOT CLEAN GLASS WHEN IT IS HOT.

⚠ DO NOT USE ABRASIVE OR AMMONIA-BASED CLEANING SOLUTIONS. TAKE CARE TO NOT SCRATCH THE GLASS SURFACE.

Glass Replacement

To remove the glass panel or glass gasket:

1. Use the Latch Tool to release the two glass frame latches on top of the firebox.
2. Swing the top of the glass frame out and lift up to disengage it from the firebox.
3. Lay the assembly on a flat surface and use a flat blade screwdriver or pliers to pry up the four steel tabs that secure the glass panel at the corners of the frame.
4. Install the new glass panel and gasket in the glass frame and secure with the steel tabs. Do not over-tighten the tabs as that could break the glass.

ALWAYS USE JØTUL AUTHORIZED PARTS. NEVER SUBSTITUTE PARTS FROM OTHER SOURCES. See fig. 10.2, page 32.

⚠ WARNING:

OBSERVE CAUTION NEAR THE GLASS. THE GLASS PANEL MAY SHATTER IF STRUCK WITH AN OBJECT. ALWAYS HANDLE THE GLASS PANEL WITH CARE.

⚠ WARNING:

INSPECT THE GLASS SURFACE FOR SCRATCHES AS THESE CAN WEAKEN THE PANEL TENSILE STRENGTH. REPLACE THE PANEL IF ANY SCRATCHES ARE EVIDENT. USE ONLY JØTUL PN 226451. DO NOT SUBSTITUTE ANY OTHER TYPE OF GLASS.

REPLACEMENT OF THE GLASS SHOULD BE DONE BY A LICENSED OR QUALIFIED SERVICE PERSON. USE ONLY REPLACEMENT GLASS PROVIDED BY YOUR AUTHORIZED JØTUL DEALER. NEVER SUBSTITUTE ANY OTHER COMPONENTS.

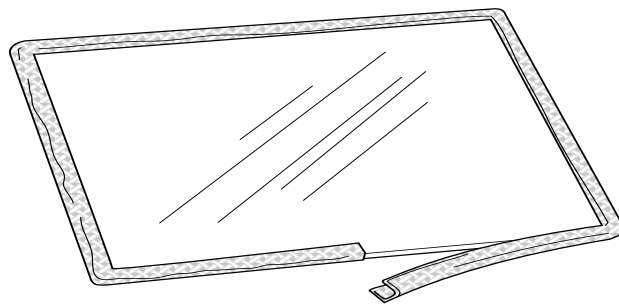

Figure 9.1. Gasket application, PN 129124.

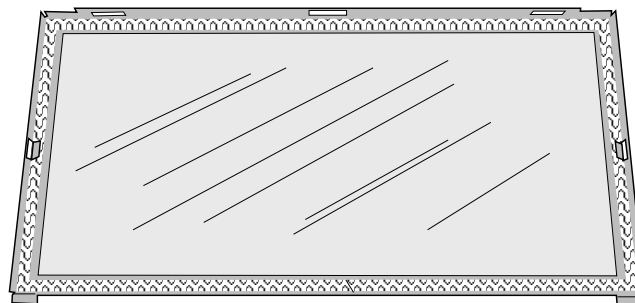

Figure 9.2. Glass Replacement. Bend tabs to secure panel. Use PN 220042 Tinnerman Clip to replace broken frame tabs.

10.0 Illustrated Part List

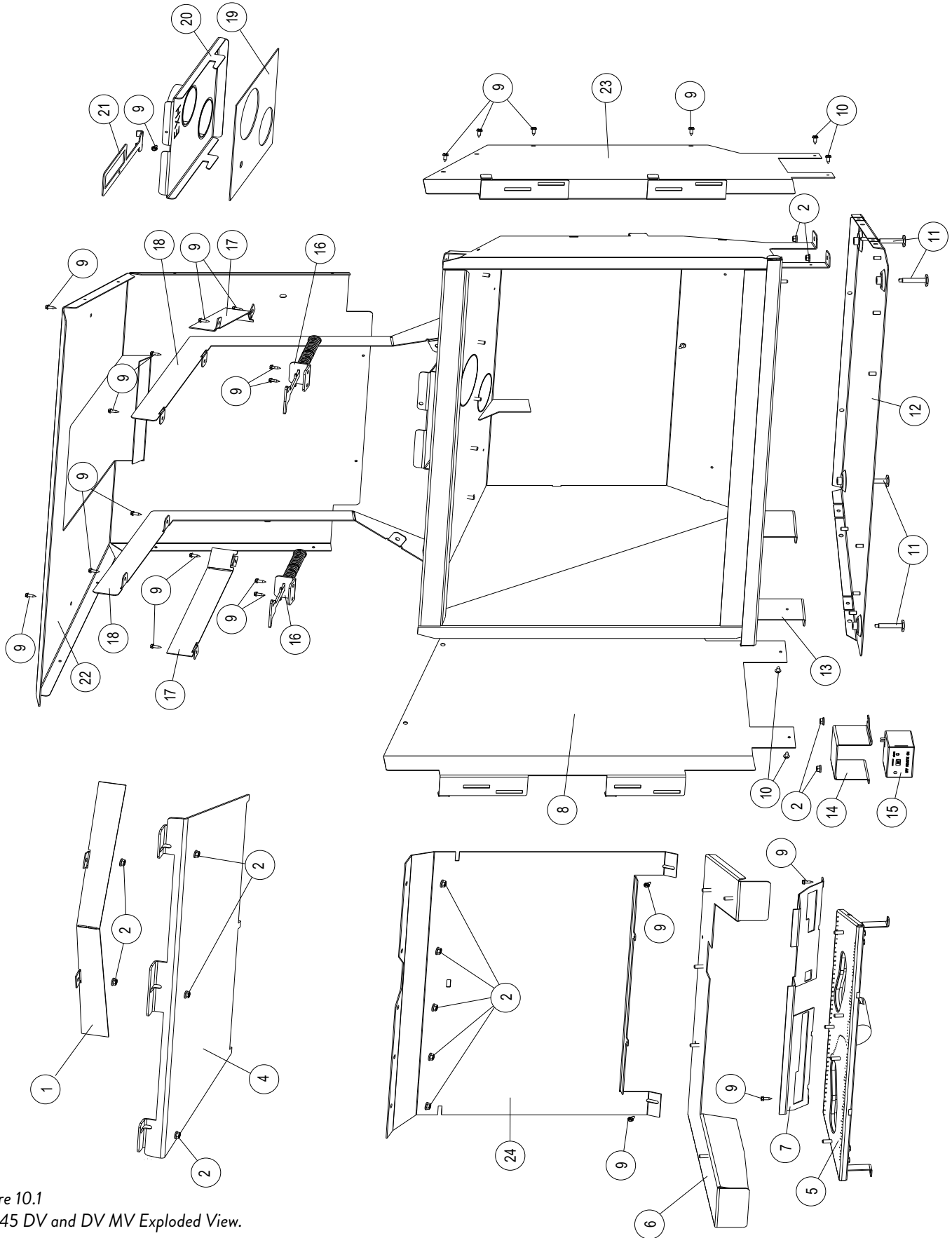

Figure 10.1
GI 645 DV and DV MV Exploded View.

No.	Part No.	Description
1	226617	Exhaust Diverter, GI645 DV
2	117968	Nut, M6 Serrated Flange plain
4	22644792	Baffle, GI645 DV
5	158116	Burner Assembly, GI645 DV
6	22645092	Burner Skirt, GI645 DV
7	226613	Secondary Air Deflector, GI645 DV
8	22645992	Cabinet, Left, GI645 DV
9	117917	Screw, HWH SMA #8 x 1/2 SL Blk Oxide
10	117999	Screw, SL SMA Type B #8 x 3/8 Zinc
11	118047	Bolt, Leveling, M8 x 40 - PIC
12	226444	Cabinet, Base, GI645 DV
13	226445	Firebox Weldment, GI645 DV
14	226416	Heat Shield, Remote Receiver, GI 545/GI645
15	224910	Remote Control Kit
16	226587	Glass Latch Assembly, GI645 DV
17	226610	Convection Air Deflector, Side, GI645 DV
18	226611	Convection Air Deflector, Large, GI645 DV
19	226646	Gasket, Vent Adapter, GI645 DV
20	226571	Vent Adapter, GI645 DV
21	226642	Latch Tool, GI 645 DV
22	226458	Top Back Shroud, GI645 DV
23	22646092	Cabinet, Right, GI645 DV
24	22644692	Air Intake Wall, GI645 DV

10.0 Illustrated Part List

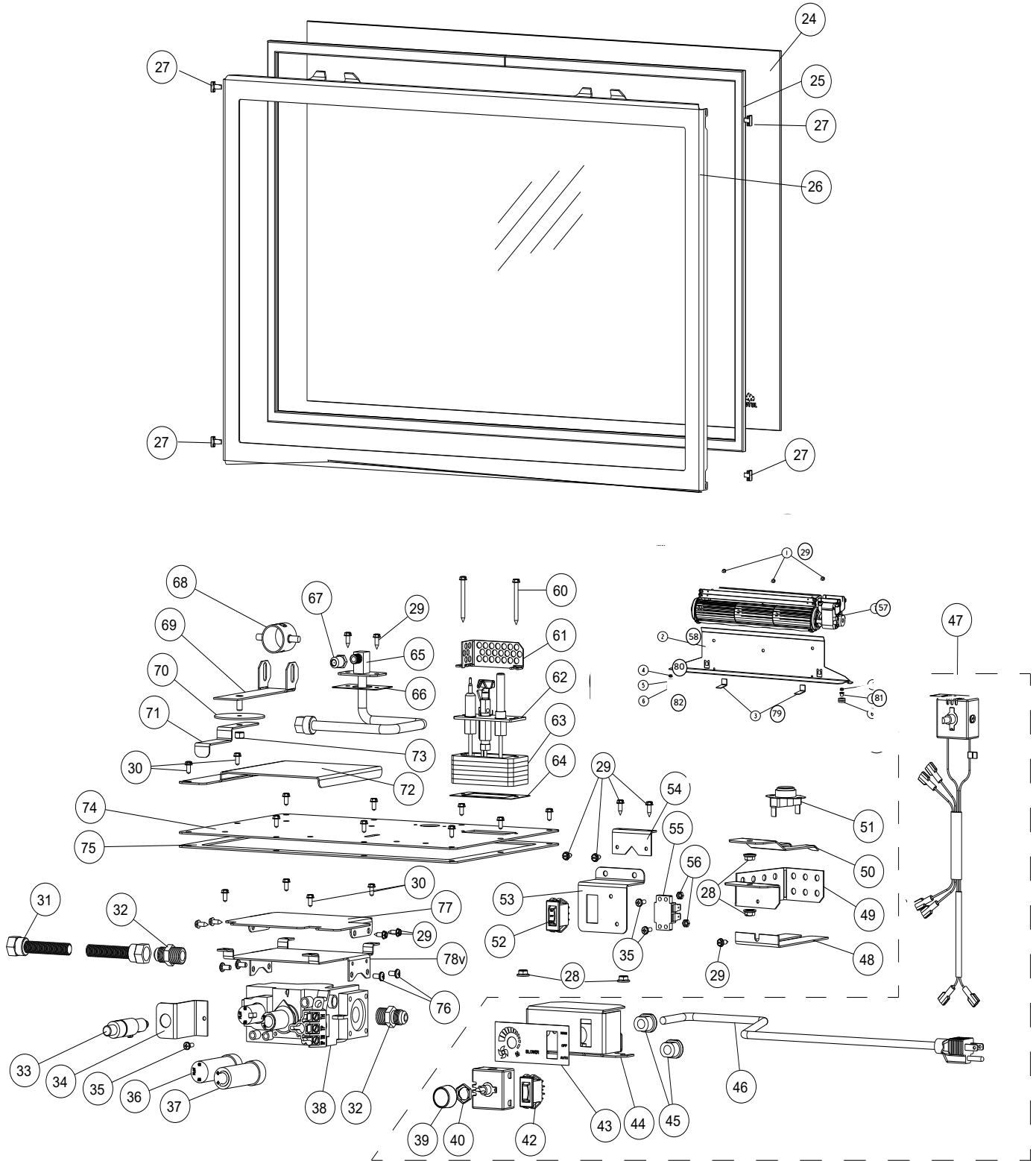

Figure 10.2
GI 645 DV and DV MV Exploded View.

No.	Part No.	Description
24	158203	Glass w/ Gasket, Ceramic, GI 645 DV
25	129124	Gasket, Tad, .25" x1.25" Nominal, Graphite
26	22644892	Glass Frame, GI645 DV
27	220042	Clip, U Type (Tinnerman)
28	117968	Nut, M6 Serrated Flange plain
29	117917	Screw, HWH SMA #8 x 1/2 SL Blk Oxide
30	117999	Screw, SL SMA Type B #8 x 3/8 Zinc
31	129707	Flex Tube, 3/8" OD x 36", 3/8" Female Flare Connectors w/Adapters
32	223215	Adapter, Straight, 3/8 NTP x 3/8" Dia Flare
33	3902573	Piezo Ignitor Button
34	226348	Igniter Bracket, GI 545/GI 645 DV
35	117920	Screw, Pan Head, Phillips, M4 X 8, Zinc
36	3902582	Extension Knob, On/Off, 3", SIT Nova 820/821
37	3902581	Extension Knob, Hi/Lo, 3", SIT Nova 820/821
38	222263 226560	Valve, NG, 50% TD, 3.8" WC, SIT 0820703 Valve, NG, 50% TD, 3.8" WC, W/POD, SIT 0821644
39	220709	Knob, Rheostat Control, 1" Dia
40	220717	Collar, Retainer, Rheostat
42	220703	Switch, Rocker, SPDT, Center Off, Black, Plain
43	138720	Decal, Blower Switch Box
44	226367	Blower Switch Box, GI 545/645 DV
45	117951	Wire Strain Relief, Heyco 7P-2 (Large)
46	158138	Power Cord Assembly, GI 545/GI 645 DV
47	158137	Blower Control Assembly
48	225063	Snapstat Finger Guard, GI450 DVII / 45i / 545
49	225069	Snapstat Shield, GI450 DV / 45i / 545 / 645
50	222951	Bracket, Snapstat, Firebox Mounted
51	220637	Snapstat, 140-120 °F, Normally Open
52	129153	Switch, Rocker, SPDT, Black, Ctr Off, Marked "ON-OFF-STAT"
53	226509	Burner Switch Panel, GI 545/645
54	129698	Support, Control Panel, GI 450/545
55	129154	Terminal Block, 2 Pole 77 series
56	117922	Nut, Hex M4, DIN 934, Plain
57	157969	Blower, Cross Flow, 12" Cage, 120 CFM
58	226311	Cover, Access Blower, GI 545/645 DV
59	221797	Rubber / Cork Strip, Adhesive Backed, .50 W x .125 T x 50' Roll
60	118262	Screw, HWH SMA #8 x 1.75" SL Zinc
61	226644	Pilot Shield, GI 645 DV
62	158221	Pilot Assembly, NG, Flat Brkt, SS Body

No.	Part No.	Description
62a	226869	Thermocouple, PSE Millivolt w/Fittings
62b	226758	Pilot Injector, SS Body Pilots, NG
62c	226759	Pilot Injector, SS Body Pilots, LP
63	225628	Pilot Spacer, 1.125" H, GF 370 DVII/GI 545/645
64	129670	Gasket, Pilot Assembly
65	223231	Orifice Holder, Drop In Assembly, 12.5" Tube
66	222280	Gasket, Drop In Orifice Holder
67	045024 129665	Orifice, #32 Orifice, 1.8mm / LP (P C MEMO)
68	221390	Primary Air Shutter Asby
69	226510	Air Shutter Holder
70	220734	Gasket, 2.25" OD x 188" ID x .125" T
71	226380	Primary Air Handle, GI 545/645 DV
72	226645	Valve Heat Shield, GI 645 DV
73	118016	Nut, Lock, M6, DIN 980V, Zinc
74	226452	Spud Plate, GI 645 DV
75	226616	Gasket, Spud Plate GI 645 DV
76	117911	Screw, Pan Head, Phillips, 10-32x3/8"
77	226581	Valve Heat Shield, GI 545/645
78	226585	Valve Bracket, GI 545/645
79	226338	Rubber / Cork Strip, Adhesive Backed
80	118055	Keplnut, M4, Ext. Tooth Lockwasher
81	118411	Sleeve Washer, Insulated Nylon #10 Screw
82	118410	Vibration Damping Grommet, .27 Dia, .33

11.0 Appendix

11.1 Approved Vent Manufacturers

This appliance is approved for installation with listed 3-inch and 4-inch diameter flexible vent components supplied by the manufacturers listed below.

**Use parts of one manufacturer only -
DO NOT MIX VENT COMPONENTS FROM
DIFFERENT MANUFACTURERS IN THE SAME
SYSTEM.**

M&G DuraVent, Inc. (Direct Vent Pro Series)

P.O. Box 1510
Vacaville, CA 95696-1510 800-835-4429

Selkirk Metalbestos (Direct Temp)

1301 W. President George Bush Hwy, Suite 330
Richardson, TX 75080-1139 800-992-8368

American Metal Products (Amerivent)

8601 Hacks Cross Rd.
Olive Branch, MS 38654 800-423-4270

Security Chimneys International Limited (Secure Vent)

2125 Monterey, Laval, Québec
Canada, H7L 3T6 450-973-9999

Metal-Fab, Inc. (Sure-Seal Direct Vent)

P.O. Box 1138
Wichita, KS 67201 316-943-2351

Industrial Chimney Corp. (ExcelDirect)

400 J-F Kennedy
St. Jerome, (Quebec)
Canada, J7Y 4B7 450-565-6336

Bernard Dalsin Manufacturing Co. (Pro Form)

5205 208th Street West
Farmington, MN 55024 651- 460-1080

Olympia Chimney Supply Inc. (Ventis Direct Vent)

600 Sanders Street Suite 2
Scranton, PA 18505-3400 570-496-8890

11.2 GI 645 DV / GI 645 DV MV Fireplace Insert Limited Warranty

Effective January 1, 2019

This warranty policy applies to gas products identified by Jøtul trade names, as set forth below.

A. LIMITED FIVE YEAR WARRANTY - Cast Iron, Steel Doors, Surround Components, Firebox:

Jøtul North America Inc. (JØTUL) warrants, to the original retail purchaser, that those components of the Jøtul Gas Stove or Fireplace Insert specified above will be free of defects in material and workmanship for a period of five (5) years from the date of purchase. This warranty is subject to the terms, exclusions and limitations set forth in the following text.

B. LIMITED TWO YEAR WARRANTY - Burner, Burner Treatments, Firebox Panels:

JØTUL warrants, to the original retail purchaser, that those components of the Jøtul Stove or Fireplace Insert specified above will be free of defects in material and workmanship for a period of two (2) years from the date of purchase. This warranty is subject to the terms, exclusions, and limitations set forth in the following text.

C. LIMITED TWO YEAR WARRANTY - Enamel Finish:

JØTUL warrants, to the original retail purchaser, the enamel finish on cast iron components of the Jøtul Stove or Fireplace Insert specified above against peeling or fading for a period of two (2) years from the date of purchase. This warranty is subject to the terms, exclusions and limitations set forth below.

D. LIMITED ONE YEAR WARRANTY - Gas & Electrical Components (controls, plumbing, valve, blower):

JØTUL warrants, to the original retail purchaser, that those components of the Jøtul Gas Stove or Fireplace Insert specified above will be free of defects in material and workmanship for a period of one (1) year from the date of purchase. This warranty is subject to the terms, exclusions, and limitations set forth in the following text.

JØTUL will repair or replace (including parts & labor), at its option, any of the above components determined by JØTUL to be covered by this warranty. You must, at your own expense, arrange to deliver or ship the component to an authorized Jøtul dealer and arrange for pickup or delivery of the component after repairs have been made. If, upon inspection, JØTUL determines that the component is covered by this warranty, the repair or replacement will be made as set forth above. This warranty is not transferable and is extended only to, and is solely for the benefit of, the original retail purchaser of the Jøtul Gas Stove or Fireplace Insert. This paragraph sets forth the sole remedy available under this warranty in the event of any defect in the Jøtul Gas Stove or Fireplace Insert.

The warranty period for any replaced component will be the remaining unexpired portion of the warranty period for the original component.

Please retain your dated sales receipt in your records as proof of purchase.

EXCLUSIONS AND LIMITATIONS

NOTICE: This warranty is void if installation or service is performed by someone other than an authorized installer, service agency or gas supplier, or if installation is not in conformance with the installation and operating instructions contained in this owner's manual or local and/or national fire and building regulations. A listing of local authorized installers, service agencies and gas suppliers can be obtained from the National Fireplace Institute at <http://www.nficertified.org/>.

This warranty does not cover the following:

- 1) Repair or replacement of parts that are subject to normal wear and tear during the warranty period or to parts that may require replacement in connection with normal maintenance. These parts include gaskets, paint and glass (except to the extent such parts suffer damage from thermal stress).

- 2) Damage due to incorrect installations not in conformance with the installation instructions contained in this owner's manual or local and/or national fire and building regulations.
- 3) Damage due to service performed by an installer, service agency or gas supplier, unless otherwise agreed to in writing by JØTUL.
- 4) Labor or other costs associated with the repair of gas controls, plumbing, burners, log set, or sheet metal firebox beyond the warranty period.
- 5) Damage caused by unauthorized modification, use or repair.
- 6) Damage to enameled surfaces caused by improper operation or misuse, including use that is not in conformance with the operating instructions contained in this owner's manual. Such damage can typically be identified by bubbling, cracking, or discoloration of the enamel finish.
- 7) Costs incurred by travel time and/or loss of service.
- 8) Damage incurred while the Jøtul Gas Stove or Fireplace Insert is in transit.

IN NO EVENT SHALL JØTUL, ITS PARENT COMPANY, SHAREHOLDERS, AFFILIATES, OFFICERS, EMPLOYEES, AGENTS OR REPRESENTATIVES BE LIABLE OR RESPONSIBLE TO YOU FOR ANY SPECIAL, INDIRECT, INCIDENTAL, CONSEQUENTIAL, PUNITIVE OR OTHER SIMILAR DAMAGES, INCLUDING, BUT NOT LIMITED TO, LOST PROFITS, LOST SALES, INJURY TO PERSON OR PROPERTY, OR DAMAGES TO A STRUCTURE OR ITS CONTENTS, ARISING UNDER ANY THEORY OF LAW WHATSOEVER. ALL IMPLIED WARRANTIES, INCLUDING THE IMPLIED WARRANTIES OF MERCHANTABILITY AND FITNESS FOR A PARTICULAR PURPOSE, OR OTHERWISE, ARE LIMITED IN DURATION TO THE LENGTH OF THIS WRITTEN WARRANTY. EXCEPT AS EXPRESSLY SET FORTH HEREIN, JØTUL MAKES NO ORAL, WRITTEN OR OTHER WARRANTY WITH RESPECT TO JØTUL GAS STOVES OR FIREPLACE INSERTS.

Some states do not allow the exclusion or limitation of incidental or consequential damages, or limitations on the length of implied warranties. Therefore, the above exclusions or limitations may not apply to you. This warranty gives you specific legal rights, and you may have other rights, which vary from state to state.

JØTUL reserves the right to discontinue, modify or change the materials used to produce the Jøtul, Scan, or Atra Gas Stove or Fireplace. JØTUL shall have the right to replace any defective component with substitute components determined by JØTUL to be of substantially equal quality and price.

The dollar value of JØTUL's liability for breach of this warranty shall be limited exclusively to the cost of furnishing a replacement component. JØTUL shall not in any event be liable for the cost of labor expended by others in connection with any defective component. Any costs or expenses beyond those expressly assumed by JØTUL under the terms of this warranty shall be the sole responsibility of the owner(s) of the Jøtul Gas Stove or Fireplace Insert. No dealer, distributor, or other person is authorized to modify, augment, or extend this limited warranty on behalf of JØTUL. **NO MODIFICATION OR CHANGE TO THIS WARRANTY WILL BE EFFECTIVE UNLESS IT IS MADE IN A WRITTEN DOCUMENT MANUALLY SIGNED BY AN AUTHORIZED OFFICER OF JØTUL.**

An authorized installer may have been provided with certain information related particularly to the Jøtul Gas Stove or Fireplace Insert; however, no authorized installer or other person who may service the appliance is an agent of JØTUL. No inference should be made that JØTUL has tested, certified, or otherwise pronounced any person as qualified to install or service the appliance. JØTUL shall not be liable or otherwise responsible for any error or omission by a person installing or servicing a Jøtul Gas Stove or Fireplace Insert.

If you believe your Jøtul Gas Stove or Fireplace Insert is defective, you should contact your nearest authorized Jøtul dealer, who will process a warranty claim. **IN ORDER TO QUALIFY FOR WARRANTY COVERAGE, JØTUL MUST RECEIVE NOTICE OF A POSSIBLE DEFECT WITHIN SIXTY (60) DAYS OF THE DATE THE DEFECT IS FIRST DISCOVERED, OR REASONABLY COULD HAVE BEEN DISCOVERED.**

This warranty is given by Jøtul North America, Inc.,
55 Hutcherson Drive, Gorham, Maine 04038 USA

Troubleshooting Tips

Observe the following items if your test results do not meet specifications.

Pilot Flame is Weak, Incorrect/Abnormal Flame Picture:

- Confirm inlet pressure.
- If inlet pressure is good, clean pilot assembly.

Cleaning Procedure for PSE 820 Pilots:

1. Remove Pilot Hood using 7/16" wrench.
2. Turn upside down and look for debris. Clean head using an emory cloth. **DO NOT USE STEEL WOOL.** If corrosion is found, pilot assembly must be replaced.
3. Blow out gas line. Depress knob on valve as if trying to light pilot. Valve will supply gas to clean line.
4. Reinstall pilot hood.
5. Test pilot flame. If problems persist, replace entire pilot assembly. See illustrated parts list for part numbers.

Burner Light-off is Greater than 4 Seconds or Hesitation Anywhere on Burner

1. Remove log set from stove and place on a secure surface.
2. Inspect for loose media preventing function of burner ports especially carry-over ports. Remove Rock Wool in areas where carry-over ignition is not immediate. If removal of rock wool does not improve carry-over, use a paper clip to gently plunge through ports to ensure there is no obstruction in burner port. If burner fails after retest, move to step 3.
3. Remove burner system from unit and flip over. Clean using canned or compressed shop air through venturi tubes. **DO NOT USE BRUSH OR VACUUM TO CLEAN BURNER.**
4. If light-off is still greater than 4 seconds or has hesitation, replace burner.

Low Inlet Pressure:

- Is gas supply shut-off valve fully open?
- Check for restriction in the fuel line.
- Is supply regulator setting correct for total household gas demand?
- Is gas line properly sized?

Low Manifold Pressure:

- Confirm correct inlet pressure.
- Replace regulator tower in the gas control valve.
- Replace valve.

Service should only be performed by a licensed gas service technician. If these instructions are not followed exactly, a fire, explosion, or production of carbon monoxide may result causing property damage, personal injury or loss of life. Call your authorized Jøtul dealer for more information.

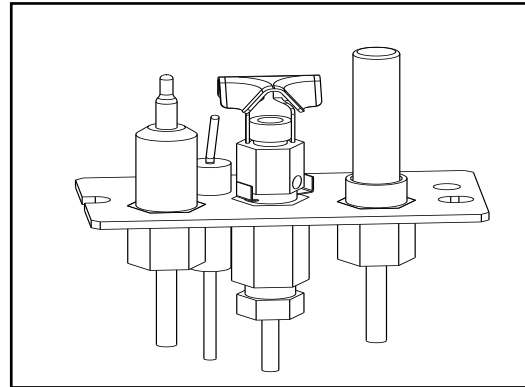

Figure 11. Pilot Assembly

This page is intentionally left blank

This page is intentionally left blank

LIGHTING INSTRUCTIONS

FOR YOUR SAFETY, READ BEFORE LIGHTING.

WARNING:
IF YOU DO NOT FOLLOW THESE INSTRUCTIONS EXACTLY, A FIRE OR EXPLOSION MAY RESULT CAUSING PROPERTY DAMAGE, PERSONAL INJURY, OR LOSS OF LIFE.

- A. This appliance has a pilot which must be lit by hand. When lighting the pilot, follow these instructions exactly.
- B. **BEFORE LIGHTING**, smell all around the appliance area for gas. Be sure to smell next to the floor because some gas is heavier than air and will settle to the floor.



WHAT TO DO IF YOU SMELL GAS:

- Extinguish any open flame.
 - Open windows.
 - Do not light any appliance.
 - Do not touch any electrical switches.
 - Do not use any phone in your building.
 - Immediately call your gas supplier from a neighbor's phone.
- If your gas supplier cannot be reached, call the fire department.
- C. Use only your hand to push in or turn the gas control knob. Never use tools. If the knob will not push in or turn by hand, do not try to repair it. Call a qualified technician. Force or attempted repair may result in a fire or explosion.
- D. Do not use this appliance if any part has been under water. Immediately call a qualified service technician to inspect the appliance and to replace any part of the control system and any gas control which has been under water.

LIGHTING INSTRUCTIONS

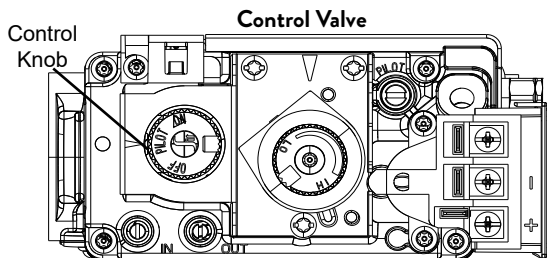
1. **STOP!** Read the safety information above.
2. Access the lower controls.
3. Turn the stove ON/OFF switch to "OFF", or set the thermostat to lowest setting (if used).
4. Confirm that the gas supply line shut-off valve is open.



5. Push in gas control knob slightly and turn clockwise  to "OFF".
NOTE: Knob cannot be turned from "PILOT" to "OFF" unless the knob is pushed in slightly. Do not force.
6. Wait five (5) minutes to clear out any gas. If you then smell gas, **STOP!** Follow "B" in the safety information above on this page. If you do not smell gas, go to the next step.
7. Push in gas control knob slightly and turn counterclockwise  to "PILOT".
8. Push in control knob all the way and hold in. Immediately

light the pilot by triggering the spark ignitor (push the red button repeatedly) until pilot lights. Continue to hold the control knob in for about one minute after the pilot lights. Release knob and it should spring back. The pilot should remain lit. If it goes out, repeat Steps 5 through 8.

- If knob does not return when released, stop and immediately call your service technician or gas supplier.
- If pilot will not stay lit after several tries, turn the control knob to OFF and call your service technician or gas supplier.

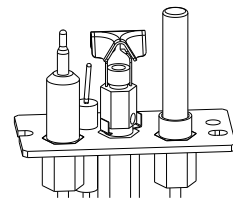

Pilot Assembly

9. Turn gas control knob counterclockwise  to "ON".
10. Turn the stove ON/OFF switch to "ON", or set thermostat (if used) to desired temperature.
11. **NOTE: MV MODELS ONLY** - the pilot will automatically shut off if there is no call for heat within seven days. Relight the pilot following the preceding steps in order.

TO TURN OFF GAS TO THE APPLIANCE:

1. Turn ON/OFF switch to "OFF". The pilot will remain lit for normal service.
2. For complete shutdown, turn ON/OFF switch to "OFF".
3. Access the lower controls.
4. Depress gas control knob slightly and turn clockwise  to OFF". Do not force.

July 2022
139987-5

This appliance must be installed in conformance with local and national building regulations. Before beginning the installation, it is important that these instructions be carefully read and understood.

Jøtul maintains a policy of continuous product development. Consequently, products may differ in specification, color or type of accessories from those illustrated or described in various publications.

Your fireplace insert has a unique serial number imprinted on the rating plate which is located in the valve compartment. Please record the serial number in the space below. You may also wish to attach your purchase receipt to this manual for future reference.

MODEL: Jøtul GI 645 DV _____ Jøtul GI 645 DV MV _____

SERIAL NUMBER: _____

DATE OF PURCHASE: _____

AUTHORIZED DEALER: _____

ADDRESS _____

PHONE: _____

INSTALLER: _____ DATE: _____

FUEL TYPE: NG _____ LP _____

FUEL CONVERSION: NO _____ YES _____

NOTES: _____



Jøtul North America
55 Hutcherson Drive
Gorham, Maine 04038-2634

www.jotul.us